

Trimble TSC5 Controller

Powered by Android™ 10

USER GUIDE

Model: 121900
Version 1.00
Revision A
March 2021

Corporate Office

Trimble Inc.
935 Stewart Drive
Sunnyvale, CA 94085
USA
www.trimble.com

Geospatial Division

10368 Westmoor Drive
Westminster, Colorado 80021
USA

Trimble, Inc.
4450 Gibson Dr
Tipp City, OH 45371, USA

Trimble, Inc. Europe
Box 64, SE-182 11 Danderyd,
Sweden

Global technical support

To request detailed technical assistance for Trimble solutions, contact trimble_support@trimble.com or locate the appropriate [Trimble Support representative](#) for your solution.

Copyright and trademarks

© 2021, Trimble Inc. All rights reserved.

Trimble and the Globe & Triangle logo are trademarks of Trimble Inc., registered in the United States and in other countries. Access is a trademark of Trimble Inc.

Spectra Geospatial is a Division of Trimble Inc. Spectra and the Spectra Geospatial logo are trademarks of Trimble Inc. or its subsidiaries.

Google, Google Play and other marks are trademarks of Google LLC. The Android robot is reproduced or modified from work created and shared by Google and used according to terms described in the Creative Commons 3.0 Attribution License.

Microsoft and Windows are either registered trademarks or trademarks of Microsoft Corporation in the United States and/or other countries.

The Bluetooth word mark and logos are owned by the Bluetooth SIG, Inc. and any use of such marks by Trimble Inc. is under license. All other trademarks are the property of their respective owners.

Release Notice

This is the March 2021 release (Revision A) of the Trimble TSC5 controller documentation, Trimble Geospatial Division.

European declaration of conformity

According to ISO / IEC Guide 22 and EN 450 14

Manufacturer's Name: Trimble Inc.

Manufacturer's Address: 4408 Gibson Dr, Tipp City, OH 45371

Declares, under our sole responsibility, that the product:

Product Name: Ranger 5 / TSC5

Model Number(s): 121900

Spectrum and maximum power: BT 13dBm; Wi-Fi 2.4GHz 17dBm; Wi-Fi 5GHz 19dBm

Conforms to the following Product Specifications:

2014/53/EU LVD 2014/35/EU EMC 2014/53/EU

R&TTE Directive 1999/5/EC

- ETSI EN 300 328
- ETSI EN 300 328 V1.8.1 (2012-06)
- ETSI EN 300 893
- ETSI EN 301 489-1 V1.9.2 (2011-09)
- ETSI EN 301 489-3
- ETSI EN 301 489-17 V2.2.1 (2012-09)
- ETSI EN 303 413
- EN 55022: 2010+AC: 2011
- EN 55024: 2010+A1:2015
- EN 55032: 2012+AC: 2013
- EN 60950-1 (2001)
- EN 60950-1:2006/A11:2009/A1:2010/
- EN 61000-3-2: 2006+A2: 2009
- EN 61000-3-3: 2013
- EN 62368-1:2014

Supplementary information

In addition, the product is battery powered and the power supply provided with this product has been certified to IEC 60950 +A1, A2, A3, A4, A11. As manufacturer, we declare under our sole responsibility that the equipment follows the provisions of the Standards stated above.

Importer of Record

Trimble European Regional Fulfillment Center

Logistics Manager

Trimble Europe B.V. & Trimble International B.V.

Industrieweg 187a

5683 CC Best

The Netherlands

Trimble EC

Trimble Germany
 Am Prime Parc 11
 65479 Raunheim
 Germany

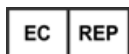

CAUTION - Only approved accessories may be used with this equipment. In general, all cables must be high quality, shielded, correctly terminated and normally restricted to two meters in length. Power supplies approved for this product employ special provisions to avoid radio interference and should not be altered or substituted. Unapproved modifications or operations beyond or in conflict with these instructions for use may void authorization by the authorities to operate the equipment.

Recycling information

You should dispose of the device and accessories properly according to local laws and regulations. Because the device contains electronic components, it must be disposed of separately from household waste. When the device reaches its end of life, contact your local Trimble reseller to learn about disposal and recycling options for your area.

Recycling in Europe

The symbol at right means that according to local laws and regulations your product and/or its battery shall be disposed of separately from household waste. When this product reaches its end of life, take it to a collection point designated by local authorities. The separate collection and recycling of your product and/or its battery at the time of disposal will help conserve natural resources and ensure that it is recycled in a manner that protects human health and the environment.

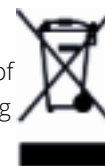

For information about recycling Trimble WEEE (Waste Electrical and Electronic Equipment) products that run on electrical power go to http://www.trimble.com/corporate/about_WEEE_ROHS_initiatives.aspx.

To recycle Trimble WEEE products call +31 497 53 24 30, and ask for the "WEEE Associate". or mail a request for recycling instructions to:

Trimble Europe B.V. & Trimble International B.V.
 Industrieweg 187a
 5683 CC Best
 The Netherlands

Taiwan – Battery Recycling Requirements

The product contains a Lithium-ion battery. Taiwanese regulations require that waste batteries are recycled.



廢電池請回收

Regional compliance

Australia and New Zealand

This product conforms with the regulatory requirements of the Australian Communications and Media Authority (ACMA) Telecommunications, Radiocommunications and EMC Labelling Notices, thus satisfying the requirements for RCM marking and sale within Australia and New Zealand.



Europe

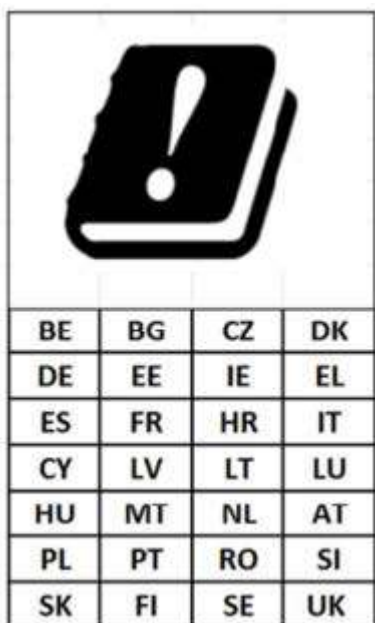

This Trimble product has been tested and found to comply with all requirements for CE Marking and sale within the European Economic Area (EEA). The device has Bluetooth and wireless LAN approval and satisfies the requirements for Radio and Telecommunication Terminal Equipment specified by European Council Directive 1999/5/EC. These requirements provide reasonable protection against harmful interference when the equipment is operated appropriately in a residential or commercial environment.

Canada

IC ID: 5817A-EM7455 / 5817A-121900

This digital apparatus does not exceed the Class B limits for radio noise emissions from digital apparatus as set out in the radio interference regulations of the Canadian Department of Communications.

Le présent appareil numérique n'émet pas de bruits radioélectriques dépassant les limites applicables aux appareils numériques de Classe B prescrites dans le règlement sur le brouillage radioélectrique édicté par le Ministère des Communications du Canada.

Changes and modifications not expressly approved by the manufacturer or registrant of this equipment can void your authority to operate this equipment under Industry Canada rules.

Les changements et modifications non expressément approuvés par le fabricant ou le détenteur de cet équipement peuvent annuler votre droit à utiliser cet appareil en vertu des règles d'Industrie Canada.

Licence exempt

This device complies with Industry Canada licence-exempt RSS standard(s). Operation is subject to the following two conditions:

- (1) this device may not cause interference, and
- (2) this device must accept any interference, including interference that may cause undesired operation of the device.

Le présent appareil est conforme aux CNR d'Industrie Canada applicables aux appareils radio exempts de licence. L'exploitation est autorisée aux deux conditions suivantes :

- (1) l'appareil ne doit pas produire de brouillage, et
- (2) l'utilisateur de l'appareil doit accepter tout brouillage radioélectrique subi, même si le brouillage est susceptible d'en compromettre le fonctionnement.

This Class B digital apparatus complies with Canadian ICES-003.

Cet appareil numérique de la classe B est conforme à la norme NMB-003 du Canada.

This Category II radio communication device complies with Industry Canada Standard RSS-310.

Ce dispositif de radiocommunication de catégorie II respecte la norme CNR-310 d'Industrie Canada.

IMPORTANT NOTE: IC Radiation Exposure Statement

For satisfying FCC RF exposure compliance requirements, body-worn operations are restricted to belt-clips, holsters or similar accessories that have no metallic component in the assembly and must provide at least 10 mm separation between the device and the user's body. This device and its antenna(s) must not be co-located or operating in conjunction with any other antenna or transmitter. The County Code Selection feature is disabled for products marketed in the US/Canada.

Pour satisfaire aux exigences de conformité d'exposition RF de la FCC, les opérations portées sur le corps sont limitées aux clips de ceinture, aux étuis ou aux accessoires similaires qui n'ont pas de composant métallique dans l'assemblage et doivent fournir une séparation d'au moins 10 mm entre l'appareil et le corps de l'utilisateur. Cet appareil et son (ses) antenne (s) ne doivent pas être colocalisés ou fonctionner avec une autre antenne ou émetteur. La fonction de sélection du code de comté est désactivée pour les produits commercialisés aux États-Unis / au Canada.

IC SAR warning**Radio Frequency (RF) Exposure Information**

The radiated output power of the Wireless Device is below the Industry Canada (IC) radio frequency exposure limits. The Wireless Device should be used in such a manner such that the potential for human contact during normal operation is minimized.

This device has been evaluated for and shown compliant with the IC Specific Absorption Rate ("SAR") limits when installed in specific host products operated in portable exposure conditions.

Informations concernant l'exposition aux fréquences radio (RF)

La puissance de sortie émise par l'appareil de sans fil est inférieure à la limite d'exposition aux fréquences radio d'Industrie Canada (IC). Utilisez l'appareil de sans fil de façon à minimiser les contacts humains lors du fonctionnement normal.

Ce périphérique a été évalué et démontré conforme aux limites SAR (Specific Absorption Rate – Taux d'absorption spécifique) d'IC lorsqu'il est installé dans des produits hôtes particuliers qui fonctionnent dans des conditions d'exposition à des appareils portables.

The device could automatically discontinue transmission in case of absence of information to transmit, or operational failure. Note that this is not intended to prohibit transmission of control or signaling information or the use of repetitive codes where required by the technology.

The device for the band 5150-5250 MHz is only for indoor usage to reduce potential for harmful interference to co-channel mobile satellite systems; the maximum antenna gain permitted (for devices in the bands 5250-5350 MHz and 5470-5725 MHz) to comply with the e.i.r.p. limit; and The maximum antenna gain permitted (for devices in the band 5725-5850 MHz) to comply with the e.i.r.p. limits specified for point-to-point and non-point-to-point operation as appropriate, as stated in section A9.2(3). In addition, High-power radars are allocated as primary users (meaning they have priority) of the band 5250-5350 MHz and this radar could cause interference and/or damage to LE-LAN devices.

Le dispositif pour la bande 5150-5250 MHz est uniquement destiné à une utilisation en intérieur afin de réduire les risques d'interférences nuisibles aux systèmes mobiles par satellite dans le même canal; le gain d'antenne maximal autorisé (pour les appareils dans les bandes 5250-5350 MHz et 5470-5725 MHz) pour se conformer à la p.i.r.e. limite; et Le gain d'antenne maximal autorisé (pour les appareils dans la bande 5725-5850 MHz) pour se conformer à la p.i.r.e. limites spécifiées pour le fonctionnement point à point et non point à point, selon le cas, comme indiqué dans la section A9.2 (3). De plus, les radars haute puissance sont attribués comme utilisateurs principaux (c'est-à-dire qu'ils ont la priorité) de la bande 5250-5350 MHz et ce radar pourrait causer des interférences et / ou endommager les dispositifs LE-LAN.

U.S.

FCC ID: S9E-121900

FCC Compliance Statement

This equipment has been tested and found to comply with the limits for a Class B digital device pursuant to Part 15 of the FCC Rules. Operation is subject to the following two conditions: (1) this device may not cause harmful interference, and (2) this device must accept any interference received, including interference that may cause undesired operation.

This equipment generates, uses, and can radiate radio frequency energy and, if not installed and used in accordance with the instructions may cause harmful interference to radio communication. However, there is no guarantee that interference will not occur in a particular installation. If this equipment does cause harmful interference to radio or television reception, which can be determined by turning the equipment off and on, the user is encouraged to try to correct the interference by one or more of the following measures:

- Reorient or relocate the receiving antenna.
- Increase the separation between the equipment and the receiver.
- Connect the equipment into an outlet on a circuit different from that to which the receiver is connected.
- Consult the dealer or an experienced radio/TV technician for help.

Changes and modifications not expressly approved by the manufacturer or registrant of this equipment can void your authority to operate this equipment under Federal Communications Commission rules.

The radios in this device have been designed and manufactured to not exceed stipulated emission limits for exposure to radio frequency (RF) energy as required by the Federal Communications Commission of the U.S. Government 47 C.F.R. § 2.1091 and 2.1093.

For satisfying FCC RF exposure compliance requirements, body-worn operations are restricted to belt-clips, holsters or similar accessories that have no metallic component in the assembly and must provide at least 10 mm separation between the device and the user's body. This device and its antenna(s) must not be co-located or operating in conjunction with any other antenna or transmitter. The County Code Selection feature is disabled for products marketed in the US/Canada. This device and its antenna(s) must not be co-located or operating in conjunction with any other antenna or transmitter. The County Code Selection feature is disabled for products marketed in the US/Canada.

Operation on the 5.15-5.25GHz frequency band is restricted to indoor use only. The FCC requires indoor use for the 5.15-5.25GHz band to reduce the potential for harmful interference to co-channel Mobile Satellite

Systems. Therefore, it will only transmit on the 5.25-5.35 GHz, 5.47-5.725 GHz and 5.725 –5.850 GHz band when associated with an access point (AP).

CE

a. Caution:

- Risk of explosion if battery replaced by an incorrect type.
- Dispose of used batteries according to the instructions.

b. Make sure the temperature for the adapter while charging is within 0-25 °C (32-77 °F).

Limited Warranty Terms and Conditions

Product Limited Warranty

Subject to the terms and conditions set forth herein, Trimble Inc. ("Trimble") warrants that for a period of (2) years from date of purchase this Trimble product (the "Product") will substantially conform to Trimble's publicly available specifications for the Product and that the hardware and any storage media components of the Product will be substantially free from defects in materials and workmanship.

Product Software

Product software, whether built into hardware circuitry as firmware, provided as a standalone computer software product, embedded in flash memory, or stored on magnetic or other media, is licensed solely for use with or as an integral part of the Product and is not sold. The terms of the end user license agreement, as included below, govern the use of the Product Software, including any differing limited warranty terms, exclusions and limitations, which shall control over the terms and conditions set forth in the limited Product warranty.

Warranty Remedies

If the Trimble Product fails during the warranty period for reasons covered by this limited warranty and you notify Trimble of such failure during the warranty period, Trimble will repair OR replace the nonconforming Product with new, equivalent to new, or reconditioned parts or Product, OR refund the Product purchase price paid by you, at Trimble's option, upon your return of the Product in accordance with Trimble's product return procedures then in effect.

How to Obtain Warranty Service

To obtain warranty service for the Product, it is recommended you contact your Trimble dealer. Alternatively, you may contact Trimble to request warranty service by emailing Repair_Services@Trimble.com. Please be prepared to provide:

- your name, address, and telephone numbers;
- product name, part number and serial number;
- proof of purchase;
- an explanation of the problem.

The customer service representative may need additional information from you depending on the nature of the problem.

Warranty Exclusions and Disclaimer

This Product limited warranty shall only apply in the event and to the extent that (i) the Product is properly and correctly installed, configured, interfaced, maintained, stored, and operated in accordance with Trimble's applicable operator's manual and specifications, and; (ii) the Product is not modified or misused. This Product limited warranty shall not apply to, and Trimble shall not be responsible for, defects or performance

problems resulting from (i) the combination or utilization of the Product with hardware or software products, information, data, systems, interfaces, or devices not made, supplied, or specified by Trimble; (ii) the operation of the Product under any specification other than, or in addition to, Trimble's standard specifications for its products; (iii) the unauthorized installation, modification, or use of the Product; (iv) damage caused by: accident, lightning or other electrical discharge, fresh or salt water immersion or spray (outside of Product specifications); or exposure to environmental conditions for which the Product is not intended; (v) normal wear and tear on consumable parts (e.g., batteries); or (vi) cosmetic damage. Trimble does not warrant or guarantee the results obtained through the use of the Product or Software, or that software components will operate error free.

NOTICE REGARDING PRODUCTS EQUIPPED WITH TECHNOLOGY CAPABLE OF TRACKING SATELLITE SIGNALS FROM SATELLITE BASED AUGMENTATION SYSTEMS (SBAS) (WAAS, EGNOS, GAGAN, MSAS AND LUCH), OMNISTAR, BEIDOU, GPS, GALILEO OR GLONASS SATELLITES, OR FROM IALA BEACON SOURCES: TRIMBLE IS NOT RESPONSIBLE FOR THE OPERATION OR FAILURE OF OPERATION OF ANY SATELLITE BASED POSITIONING SYSTEM OR THE AVAILABILITY OF ANY SATELLITE BASED POSITIONING SIGNALS.

THE FOREGOING LIMITED WARRANTY TERMS STATE TRIMBLE'S ENTIRE LIABILITY, AND YOUR EXCLUSIVE REMEDIES, RELATING TO THE TRIMBLE PRODUCT. EXCEPT AS OTHERWISE EXPRESSLY PROVIDED HEREIN, THE PRODUCT, AND ACCOMPANYING DOCUMENTATION AND MATERIALS ARE PROVIDED "AS-IS" AND WITHOUT EXPRESS OR IMPLIED WARRANTY OF ANY KIND, BY EITHER TRIMBLE OR ANYONE WHO HAS BEEN INVOLVED IN ITS CREATION, PRODUCTION, INSTALLATION, OR DISTRIBUTION, INCLUDING, BUT NOT LIMITED TO, THE IMPLIED WARRANTIES OF MERCHANTABILITY AND FITNESS FOR A PARTICULAR PURPOSE, TITLE, AND NONINFRINGEMENT. THE STATED EXPRESS WARRANTIES ARE IN LIEU OF ALL OBLIGATIONS OR LIABILITIES ON THE PART OF TRIMBLE ARISING OUT OF, OR IN CONNECTION WITH, ANY PRODUCT. BECAUSE SOME STATES AND JURISDICTIONS DO NOT ALLOW LIMITATIONS ON DURATION OR THE EXCLUSION OF AN IMPLIED WARRANTY, THE ABOVE LIMITATION MAY NOT APPLY TO YOU.

Limitation of Liability

TRIMBLE'S ENTIRE LIABILITY UNDER ANY PROVISION HEREIN SHALL BE LIMITED TO THE AMOUNT PAID BY YOU FOR THE PRODUCT. TO THE MAXIMUM EXTENT PERMITTED BY APPLICABLE LAW, IN NO EVENT SHALL TRIMBLE OR ITS SUPPLIERS BE LIABLE FOR ANY INDIRECT, SPECIAL, INCIDENTAL, OR CONSEQUENTIAL DAMAGE WHATSOEVER UNDER ANY CIRCUMSTANCE OR LEGAL THEORY RELATING IN ANYWAY TO THE PRODUCTS, SOFTWARE AND ACCOMPANYING DOCUMENTATION AND MATERIALS, (INCLUDING, WITHOUT LIMITATION, DAMAGES FOR LOSS OF BUSINESS PROFITS, BUSINESS INTERRUPTION, LOSS OF DATA, OR ANY OTHER PECUNIARY LOSS), REGARDLESS OF WHETHER TRIMBLE HAS BEEN ADVISED OF THE POSSIBILITY OF ANY SUCH LOSS AND REGARDLESS OF THE COURSE OF DEALING WHICH DEVELOPS OR HAS DEVELOPED BETWEEN YOU AND TRIMBLE. BECAUSE SOME STATES AND JURISDICTIONS DO NOT ALLOW THE EXCLUSION OR LIMITATION OF LIABILITY FOR CONSEQUENTIAL OR INCIDENTAL DAMAGES, THE ABOVE LIMITATION MAY NOT APPLY TO YOU.

NOTE: THE ABOVE TRIMBLE LIMITED WARRANTY PROVISIONS WILL NOT APPLY TO PRODUCTS PURCHASED IN THOSE JURISDICTIONS (E.G., MEMBER STATES OF THE EUROPEAN ECONOMIC AREA) IN WHICH PRODUCT WARRANTIES ARE THE RESPONSIBILITY OF THE LOCAL DEALER FROM WHOM THE PRODUCTS ARE ACQUIRED. IN SUCH A CASE, PLEASE CONTACT YOUR TRIMBLE DEALER FOR APPLICABLE WARRANTY INFORMATION.

Notice to Australian Purchasers - The Australian Consumer Law

Our goods come with guarantees that cannot be excluded under the Australian Consumer Law. You are entitled to a replacement or refund for a major failure and for compensation for any other reasonably foreseeable loss or damage. You are also entitled to have the goods repaired or replaced if the goods fail to be of acceptable quality and the failure does not amount to a major failure.

Trimble's warranty, as set out in the user manual accompanying this statement, or as described in the warranty card accompanying the Product you purchased, is in addition to any mandatory rights and remedies that you may have under the Australian Consumer Law.

Official Language

THE OFFICIAL LANGUAGE OF THESE TERMS AND CONDITIONS IS ENGLISH. IN THE EVENT OF A CONFLICT BETWEEN ENGLISH AND OTHER LANGUAGE VERSIONS, THE ENGLISH LANGUAGE SHALL CONTROL

Contents

Safety information	15
Battery safety	15
Power supply safety	16
Touchscreen glass	16
Service safety	17
Safe environments of use	17
Distraction	17
Telecommunications & Internet Association (TIA)	17
Specific Absorption Rate (SAR)	18
Caring for your device	18
Cleaning	18
Touchscreen care	18
Battery care	19
Product specifications	20
1 Introduction	25
Registration	26
Configuration options	26
In the box	27
Replacement and spare or optional accessories	28
Parts of the TSC5 controller	30
2 Setting up the device	31
Inserting a MicroSIM card (optional)	31
Tethering the stylus	33
Installing a screen protector	33
Attaching the pole bracket (optional)	36
Attaching the handstrap	37
Attaching an EMPOWER module (optional)	37
3 Getting started: basic operation	39
Shelf mode: charging the device for the first time	40
Using Shelf mode	40
Turning the device on, off	41
About Sleep state	41

Waking and unlocking the device	42
Restarting the device	42
Turning off the device	42
Checking the battery charge levels and LED status	42
LED charging status	43
Checking the charge level of the batteries	43
Charging the batteries	43
Making your battery last longer	44
Using the touchscreen	45
Switching between finger, glove and stylus mode	45
Using the stylus	46
Main touchscreen input gestures and functions supported on the TSC5 controller	46
Display settings: adjusting the backlight	47
Configuring Adaptive brightness	48
Manually adjusting the backlight brightness	48
Display settings: screen auto-rotation	48
Using the onscreen keypad	49
Using a USB or Bluetooth mouse	49
4 Using the integrated keyboard	50
About the keyboard controller firmware	50
Main keyboard keys	51
Configuring built-in keyboard settings	54
Built-in keyboard backlight	54
Modifier keys and Sticky keys: modes and settings	54
Keyboard status LEDs	56
5 Using the Android operating system	58
Using Accounts	58
Add a Google or other account	59
Remove a Google or other account	59
The Android interface	60
Android navigation keys	61
Status bar	61
Apps screen	61
Adding apps to a Home screen	62
Removing an app, shortcut, widget or group from the Home screen	62
Uninstalling apps	62
Using the pre-installed Google apps and other apps	63
Getting more apps	66

6	Using wireless networks	67
	Working with Wi-Fi networks	67
	Working with Wi-Fi networks	67
	Connecting to Wi-Fi	68
	Disconnecting from a Wi-Fi network	68
	Forgetting a Wi-Fi network	68
	Advanced Wi-Fi settings	69
	Managing Wi-Fi from the Status bar / Quick Settings on the Home screen	70
	Working with mobile broadband	70
	Using mobile data	70
	Locating the device's IMEI number	71
	Airplane mode	71
7	Working with GNSS	72
	Using the GNSS Status Utility	73
	Using 3rd party applications	73
	Calibrating the compass	73
8	Using accessories and connecting to other devices	75
	Connecting to USB accessories	75
	Using USB Type-C locking cables	76
	Connecting to Bluetooth accessories	77
	Turning Bluetooth on or off	77
	Pairing and connecting a Bluetooth device with the TSC5 controller	78
	Connecting to RS-232 peripherals	78
	Transferring data between your TSC5 controller and another computer	79
	Transferring data using a USB-C cable	79
	Using Trimble EMPOWER modules	80
	Attaching and removing EMPOWER modules	81
	Installing EMPOWER module drivers and software apps	81
	Configuring and controlling a module with the Trimble EMPOWER Hub application	82
9	Using the cameras	83
	Taking photos and videos	83
	Changing camera settings	84
	Enable the Camera app to access your location to geo-tag photos	85
	Viewing photos and videos	85
10	Troubleshooting, downloading updates, and repair	86
	Troubleshooting	86

Further assistance and support with the Android 10 operating system	86
Performance issues	86
EMPOWER module issues	88
Wireless connectivity issues	89
GNSS accuracy issues	89
Power and battery issues	89
Restarting or resetting the operating system	90
Operating system and software updates	91
Android 10 updates	91
Software downloads and updates	92
Repairing your device	92

Safety information

- ▶ Battery safety
- ▶ Power supply safety
- ▶ Touchscreen glass
- ▶ Service safety
- ▶ Safe environments of use
- ▶ Distraction
- ▶ Telecommunications & Internet Association (TIA)
- ▶ Specific Absorption Rate (SAR)
- ▶ Caring for your device
- ▶ Product specifications

Read this guide for important safety and health information and the terms of the Limited Warranty that apply to the Trimble® TSC5 controller that you have purchased. Keep all printed guides for future reference. Failure to follow instructions and properly set up, use, and care for this product can increase the risk of serious injury or death, or damage the device or devices.

Battery safety

Lithium-Ion batteries are classified by the U. S. Federal Government as non-hazardous waste and are safe for disposal in the normal municipal waste stream. These batteries contain recyclable materials and are accepted for recycling. Dispose of used batteries in accordance with local regulations.

 **WARNING** – Non-approved batteries will not function in the device. Use only the battery for the system for which it was specified. Only use the battery with a charging system that has been qualified with the system per this standard. Use of an unqualified battery or charger may present a risk of fire, explosion, leakage, or other hazard.

 **WARNING** – There are no user-serviceable parts in the batteries. Do not disassemble or open, crush, bend or deform, puncture, or shred the battery. Do not modify or remanufacture, attempt to insert foreign objects into the battery, immerse or expose to water or other liquids, or expose to fire, explosion, or other hazard. Do not expose to temperatures above +70 °C (+158 °F).

 **WARNING** – Improper battery use may result in a fire, explosion, or other hazard.

- Do not short circuit a battery or allow metallic or conductive objects to contact the battery terminals.
 - Avoid dropping the device or battery. If dropped, especially on a hard surface, and the user suspects damage to the battery, take it to a service center for inspection.
 - In the event of a battery leak, do not allow the liquid to come in contact with the skin or eyes. If contact has been made, wash the affected area with large amounts of water and seek medical advice.
 - Battery usage by children should be supervised.
-

Power supply safety

 **WARNING** – Use only AC and vehicle adapters intended for the device. Other external power sources may damage your product and void the warranty.

- Ensure the input voltage on the adapter matches the voltage in your location. Ensure the adapter has prongs compatible with your outlets.
 - The AC power supply is designed for indoor use only. Avoid using the AC power supply in wet areas.
 - Unplug the power supply from power when not in use.
 - Do not short the output connector.
-

Touchscreen glass

 **CAUTION** – The touchscreen on this device is made of glass. This glass could break if the device is dropped on a hard surface or receives a significant impact. If the glass chips or cracks, do not touch or attempt to remove the broken glass. Cracked or chipped glass due to misuse or abuse is not covered under the product's limited warranty.

Service safety

 **WARNING** – Do not attempt to take apart, open, service, or modify the product, accessories, or power supply. Doing so could present the risk of electric shock or other hazard. Any evidence of any attempt to open and/or modify this device, including any peeling, puncturing, or removal of any of the labels, will void the Limited Warranty.

Safe environments of use

 **WARNING** – Areas with potentially explosive atmospheres are often, but not always, posted and can include fueling areas, such as below decks on boats, fuel or chemical transfer or storage facilities, or areas where the air contains chemicals or particles, such as grain dust, or metal powders. When you are in such an area, turn off your mobile device, and do not remove or install battery chargers, AC adapters, or any other accessory. In such areas, sparks can occur and cause an explosion or fire.

Distraction

 **WARNING** – Using the device in some circumstances can distract you and may cause a dangerous situation. Observe rules that prohibit or restrict the use of mobile devices (for example, avoid operating the device while driving a vehicle).

Telecommunications & Internet Association (TIA)

Hearing Aids: Some digital wireless phones may interfere with some hearing aids. In the event of such interference, you may want to consult your service provider, or call the customer service line to discuss alternatives.

Pacemakers and Other Medical Devices: The Health Industry Manufacturers Association recommends a minimum separation of six inches be maintained between a handheld wireless phone and a pacemaker to avoid potential interference with the pacemaker. These recommendations are consistent with the independent research by and recommendations of Wireless Technology Research. Persons with pacemakers should use the ear opposite the pacemaker to minimize the potential for interference. If you have any reason to suspect that interference is taking place, turn the phone OFF immediately.

If you use any other personal medical device, consult the manufacturer of your device to determine if they are adequately shielded from external RF energy. Your physician may be able to assist you in obtaining this information.

Turn the phone OFF in health care facilities when any regulations posted in these areas instruct you to do so. Hospitals or health care facilities may be using equipment that could be sensitive to external RF energy.

Specific Absorption Rate (SAR)

This device complies with FCC and CE standards when used as designed.

SAR is measured with this device at a separation of 5 mm to the body, while transmitting at the highest certified output power level in all frequency bands of this device. Keep this device at least 5 mm away from your body to ensure exposure levels remain at or below the as-tested levels.

Caring for your device

Cleaning

Turn off the device, and disconnect it from external power. Use a soft, dampened cloth with either water or a diluted mild detergent. If a mild detergent is used, ensure all soap residue is removed. Do not use chemical cleaners.

Touchscreen care

The TSC5 controller is extremely rugged, and is designed to withstand extreme conditions and harsh treatment, however taking proper care of the touchscreen will prolong the life and ensure optimal display performance of the touchscreen of this product. Excessive or prolonged exposure to abrasives, oil, dust, chemicals, and ultraviolet light can affect the performance of your touchscreen over time.

To help protect the screen:

- **Clean it frequently.** Use a soft, lint-free cloth to wipe the screen. You can dampen the cloth with water or an eyeglass cleaner. If the display is very dirty, it can be washed off under a gently running tap.

 **WARNING** – Make sure that all ports and doors are fully closed, and that the device is not connected to an external power supply. Do not use chemical or abrasive cleaners.

- **Keep it covered when not in use.** Store the TSC5 controller in a carry case or pouch while you are in transit or not using it.
- **Keep it out of the sun when not in use.** Do not store the TSC5 controller in direct sunlight for a long time unnecessarily. Ultraviolet light and excessive heat from sun-loading heat can damage the display.

- **Use proper touchscreen tools.** Use either fingers or the TSC5 controller's stylus, or other devices specifically designed for use with capacitive touchscreens to operate the touchscreen of this device. The use of ballpoint pens, metal tools or other sharp objects to operate the touchscreen may scratch and/or damage the surface of the touchscreen.
- **Avoid drops, tumbles, and abrasives.** The TSC5 controller is designed to resist damage for drops up to 122 cm (4 feet). However, you should protect the display from impact, pressure, and abrasive substances that can scratch it or crack it. The device should not be dropped unnecessarily. Use the screen protectors to keep the touchscreen clean and protected, following the instructions provided on the screen protector packaging.

Battery care

Use and storage temperature: Lithium-ion batteries are sensitive to high temperatures, so keep the device's batteries out of direct sun for long periods, and don't leave batteries in a hot car, especially on a dashboard in full sun or other environments where temperatures can exceed +70 °C (+158 °F). Battery life can be shortened if stored or operated outside of these temperature ranges. The batteries have a storage temperature rating of -40 °C to +70 °C (-40 °F to +158 °F), however, for maximum battery life, the recommended storage temperature is at room temperature (~+20 °C / +68 °F). When you are using the device or charging the batteries, it is normal for the device and batteries to get warm.

If the interior temperature of the device exceeds normal operating temperatures (for example, in a hot car or in direct sunlight for extended periods of time), you may experience the following as it attempts to regulate its temperature automatically:

- The device stops charging.
- If the device cannot regulate its internal temperature, it may go into a Sleep state until it cools.

Move the device to a cooler location out of direct sunlight and wait a few minutes before trying to use the device again.

Charging: Recharge the batteries any time; the batteries do not need to be empty or low before you recharge them. However, it is best to let the battery run to below 10 percent at least once a month before you recharge it. Battery recharging is supported at temperatures between 0 °C to +40 °C (+32 °F to +104 °F). Use only the manufacturer designated charging accessories to recharge the batteries.

Other environmental conditions: The batteries are sealed from water and dust, and are tested for protection from drops from heights up to 122 cm (4 feet). However to prolong the life of the battery, dry it off with a cloth if it becomes wet, do not intentionally submerge the battery, and take care to avoid unnecessary drops, mechanical shocks, and vibrations.

The TSC5 controller is designed to work in ambient temperatures between -30 °C and +60 °C (-22 °F and +140 °F) and to be stored in temperatures between -40 °C and +70 °C (-40 °F and +158 °F). Avoid exposing the device to dramatic changes in temperature or humidity.

Product specifications

Physical	<p>Size L x W x H: 287.1 mm x 175.6 mm x 43.9 mm (11.3" x 6.9" x 1.7")</p> <p>Weight 934 grams (2.06 pounds), excluding the EMPOWER module, pole bracket and other accessories</p> <p>Housing PC-EXL9330 Case with TPU-TeXin990 Overmold</p>
Operating System	Android 10
Processor	Qualcomm SDA660
Graphics	Qualcomm Adreno 512 GPU
RAM	4GB LPDDR4X RAM
User Storage	64 GB Flash eMMC
Display	<p>5-inch, HD landscape display (1280x720 pixels)</p> <p>300 DPI Transflective type TFT Display</p> <p>365 cd/m2 sunlight readable LED backlight</p> <p>Contrast Ratio (typical): 800:1</p> <p>Projective capacitive multi-touch touchscreen with stylus, finger, and glove modes</p>
Keyboard	<p>International backlit Alpha-Numeric & QWERTY keyboard</p> <p>12 Programmable Function keys</p> <p>Multiple Fn, Shift & AGr key combinations</p>
Notification LED	Battery Status, Shift, Fn, Ctrl, AGr, Caps Lock, Search, and Cursor Lock LED indicator
I/O	<p>x1 USB Type-C Host/Client port for charging and USB 2.0 data transfer</p> <p>Supports USB BC 1.2 and USB-PD 2.0 charger inputs up to 9V/3A</p> <p>x1 EMPOWER module bay</p>

Battery & Power	<p>Batteries</p> <ul style="list-style-type: none"> Internal Li-Ion batteries <ul style="list-style-type: none"> 4530 mAh / 7.2V (32.6 Wh) nominal capacity <p>Battery Life</p> <ul style="list-style-type: none"> RTS workflow ~16 hours & GNSS workflow ~18 hours usage <ul style="list-style-type: none"> Depends on display settings, connectivity, data processing, ambient temperature, etc. Fully charged battery can support Sleep State for 7.2 days, Powered Off State (device is off but still powered by the battery) for >175 days, and Shelf Mode (battery is off) for 490 days. <p>Charging Time</p> <ul style="list-style-type: none"> Full-charge 3.5 hours, 0-50% charge in 1.5 hours <p>Power Input</p> <ul style="list-style-type: none"> 5V/9V, 3A charging, USB-PD compliant with Type C connector
Audio	<p>1W Mono Speaker</p> <p>Dual Microphones with noise cancelling technology</p> <p>Bluetooth or USB-C headsets supported</p>
External speaker / microphone	<p>USB-C port for external headsets</p> <p>Bluetooth headsets supported</p>
Camera	<p>Rear camera: 13MP auto-focus with LED flash</p>
GNSS	<p>Integrated Sierra Wireless EM7565 chipset</p> <p>L1 C/A GPS/GLONASS/BeiDou/Galileo/QZSS</p> <p><10 m accuracy</p>
Bluetooth	<p>Bluetooth 5 classic & BLE 5, Class 1</p> <p>1.7 Mbps at 100m range</p>
Wi-Fi	<p>2.4 GHz 802.11 b/g/n/ac & 5.0 GHz 802.11a/n/ac</p>

Mobile broadband / WWAN (optional)	<p>Worldwide LTE 4G in regions where it is available, and compatible with 3G networks</p> <p>LTE: Bands 1, 2, 3, 4, 5, 7, 8, 9, 12, 13, 18, 19, 20, 26, 28, 29, 41, 66</p> <p>UMTS (3G): Bands 1, 2, 4, 5, 6, 8, 9, 19</p> <p>AT&T and Verizon certified</p> <p>MicroSIM card</p>
Sensors	<p>Orientation: 3-axis accelerometer, Magnetic heading sensor (E-compass), 3-axis Gyro sensor</p> <p>The orientation sensors are active and applications can access and use the sensors. Use Google Play to search and browse for 3rd party tools that enable you to view sensor output.</p> <p>Display: Ambient light sensor</p>
Environmental Certifications	Conflict Minerals, China RoHS 2.0, EU RoHS 2.0, EU REACH
Safety Certifications	US/CA (UL/cUL), EU (CB), UK (UKCA), AUS/NZ (AS/NZS), China (CCC), India (TEC), Russia (CU), S. Africa (LoA+NRCS), Taiwan (BSMI), UAE (UAB.S IEC60950)
EMI/EMC Certifications	CE, FCC/IC, VCCI, C-Tick, BSMI
ESD Certifications	IEC 61000-4-2, Level 4, 8KV contact and 15KV air
RF Certifications	PTCRB, AT&T OTA, Verizon OTA, Wi-Fi RSE & SAR
Regional Compliance	US (FCC), Canada (IC), EU (CE), UK (CE), Australia (C-tick, A-tick), New Zealand (C-tick, A-tick), Japan (MIC), Thailand (NBTC), Russia (FAC), South Korea (KCC), Taiwan (NCC), UAE United Arab Emirates (GCC), Mexico (IFETEL), Brazil (ANATEL), India (ETA-SD), China (SRRC+NAL) and South Africa (ICASA)
Security	Qualcomm SDA660 Hardware Backed Encryption, Quarterly Android Security Patches, Storage Encryption, and TLS 1.3

Rugged Specifications **IEC-529:** Independently tested and certified for:

- Water Ingress Protection: IPx5
- Sand & Dust Ingress Protection: IP6x

MIL-STD-810H: Independently tested and certified for:

- Operating temperature: -30 °C to +60 °C (-22 °F to +140 °F)
 - Storage temperature: -40 °C to +70 °C (-40 °F to +158 °F)
 - Startup temperature: -20 °C to +60 °C (-4 °F to +140 °F)
 - Charging (AC adapter) temperature: 0 °C to +40 °C (+32 °F to +104 °F)
 - AC adapter / charging temperature: 0 °C to +25 °C (+32 °F to +77 °F)
 - Temperature shock: survives cycles between -30 °C and +60 °C (-22 °F and +140 °F)
 - Humidity: 90% RH temp cycle +30 °C / +60 °C (+86 °F / +140 °F)
 - Vibration: General Minimum Integrity and Loose Cargo Test
 - High altitude (low pressure)
 - Operation 9,144 m (30,000 ft) at +5 °C (+41 °F)
 - Storage 12,192 m (40,000 ft) at -30 °C (-22 °F)
 - Rapid Decompression 2,438 m (8,000 ft) to 12,192 m (40,000 ft) in <15 seconds at +25 °C (+77 °F)
 - Drop / Shock protection:
 - 26 drops at room temperature from 1.22 m (4 ft) onto concrete
 - 6 faces at high and low temperature (-30 °C and +60 °C (-22 °F and +140 °F)
 - Ball drop protection: 50 mm steel ball dropped 0.5 m on to touch panel
 - Solar Radiation Exposure: Survives prolonged solar exposure
 - Salt Spray: ASTM B117 5% salt solution, 96 hours
-

Configuration Options: x1 EMPOWER module bay supports:
EMPOWER Modules

- EM100 GNSS Receiver Module
- EM120 2.4 GHz Receiver Module
- EM11x Barcode/RFID Modules
- Custom modules

Compatible Trimble
Field Software

Android 10 applications

[Trimble Access™](#) version 2021 and later

[Trimble Siteworks Positioning System](#) version 1.40 and later

Trimble 3Log ScaleWiz

Trimble Unity Remote Monitoring and Work Management
Software

Trimble GasOps

Introduction

- ▶ Registration
- ▶ Configuration options
- ▶ In the box
- ▶ Replacement and spare or optional accessories
- ▶ Parts of the TSC5 controller

This user guide describes how to configure and use the Trimble® TSC5 controller powered by the Android™ 10 operating system. The information in this guide supplements the information in the Quick Start Guide, which you receive in the box with the device.

Even if you have used other Trimble handheld field computers, data collectors or survey controllers before, Trimble recommends that you spend some time reading this guide to learn about the special features of the product.

 **WARNING** – Before you use this product, make sure that you have read and understood all safety requirements. Failure to follow these safety instructions could result in fire, electric shock, or other injury, or damage to the device and/or other property. For more information refer to the important [Safety information, page 15](#) of this guide.

Registration

To receive information regarding updates and new products, contact your local dealer, go to the Trimble customer registration website www.trimble.com/register or go to <https://mytrimbleprotected.com/cc/productsRegistration.html>. When you register your device, you can select the newsletter, upgrade, or new product information.

To register your device, you will need the serial number—a unique 12 digit number for your TSC5 controller (for example, JAJ201300096)

The serial number (along with the Regulatory label) is on a label inside the SIM card compartment on the back of the device; see [Inserting a MicroSIM card \(optional\)](#), page 31 for instructions on removing the compartment cover.



Configuration options

The TSC5 controller is powered by the Android 10 operating system, and has a built-in QWERTY keyboard, integrated Wi-Fi, Bluetooth® wireless technology, and optional worldwide 4G LTE Cellular WWAN connectivity (data only).

For a full list of product features and their specifications, refer to the [Product specifications](#), page 20 section, or contact your local Trimble reseller for information.

In the box

A standard pack-out has the following items:

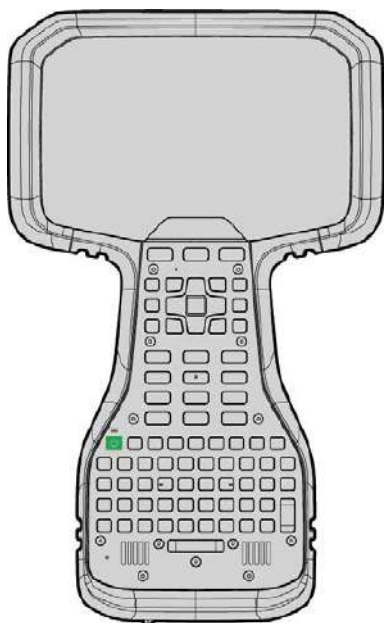

A TSC5 controller



Corning AG2bc Glass Screen Protector with Anti-UV AB Adhesive. The screen protector package includes the screen protector in a foam sleeve, and a sealed yellow pack containing:

- 70% Isopropyl Alcohol prep pad
- grey lint-free cleaning cloth
- blue lint/dust removal sticker



45W AC USB-C PD power supply with regional plug adapters (EU, UK, SAA)

- Input: 100-240VAC ~ 50/60Hz 1.3A
- Output: 45W: 5V/3A, 9V/3A, 12V/3A, 15V/3A, 20V/2.25A
 - The TSC5 controller uses 5/9V, 3A charging
- Size: 58 X 46 X 28 mm





2 m (6.56 feet) USB-Type C (male) to USB-Type C (male) USB 2.0 cable for charging and data transfer

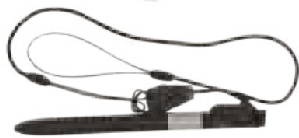

Capacitive stylus with tether and 2 stylus tips



Philips #1 screwdriver



Handstrap

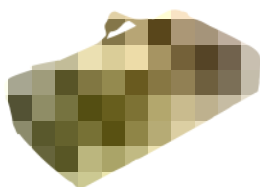

Protective soft carry case and a Quick Start Guide

Replacement and spare or optional accessories

⚠ WARNING – Only Trimble approved accessories should be used with this product. Failure to use Trimble approved accessories could result in fire, electric shock, or other injury, or damage to the handheld computer and/or other property. For more information refer to [Safety information, page 15](#).

A wide range of replacement and optional accessories are available to purchase for the TSC5 controller, including:

- AC power supply with regional plugs and USB-C port
- USB-C to USB-C cable for charging and data transfer
- Tempered glass screen protector
- Capacitive stylus with tether, 2 stylus tips
- Pack of 5 replacement stylus tips
- Handstrap
- Protective pouch
- USB-A to USB-C cable

- USB-C to USB-A adapter
- USB-C vehicle charger
- TSC5 controller pole mount bracket
- Quick release pole mount clamp and adjustable arm
- Fabric shoulder bag
- Shoulder sling

EMPOWER modules

The following EMPOWER modules are also available:

- Trimble EM120 2.4GHz Radio Module
- Trimble EM100 GNSS Receiver Module
- Trimble EM110 1D/2D Barcode Imager Module
- Trimble EM111 1D/2D Barcode Imager & UHF 902-928 MHz RFID – NA
- Trimble EM111 1D/2D Barcode Imager & UHF 865.6-867.6 MHz RFID – EU
- Trimble EM112 1D/2D Barcode Imager & UHF 902-928 MHz RFID with AEI – NA

Parts of the TSC5 controller

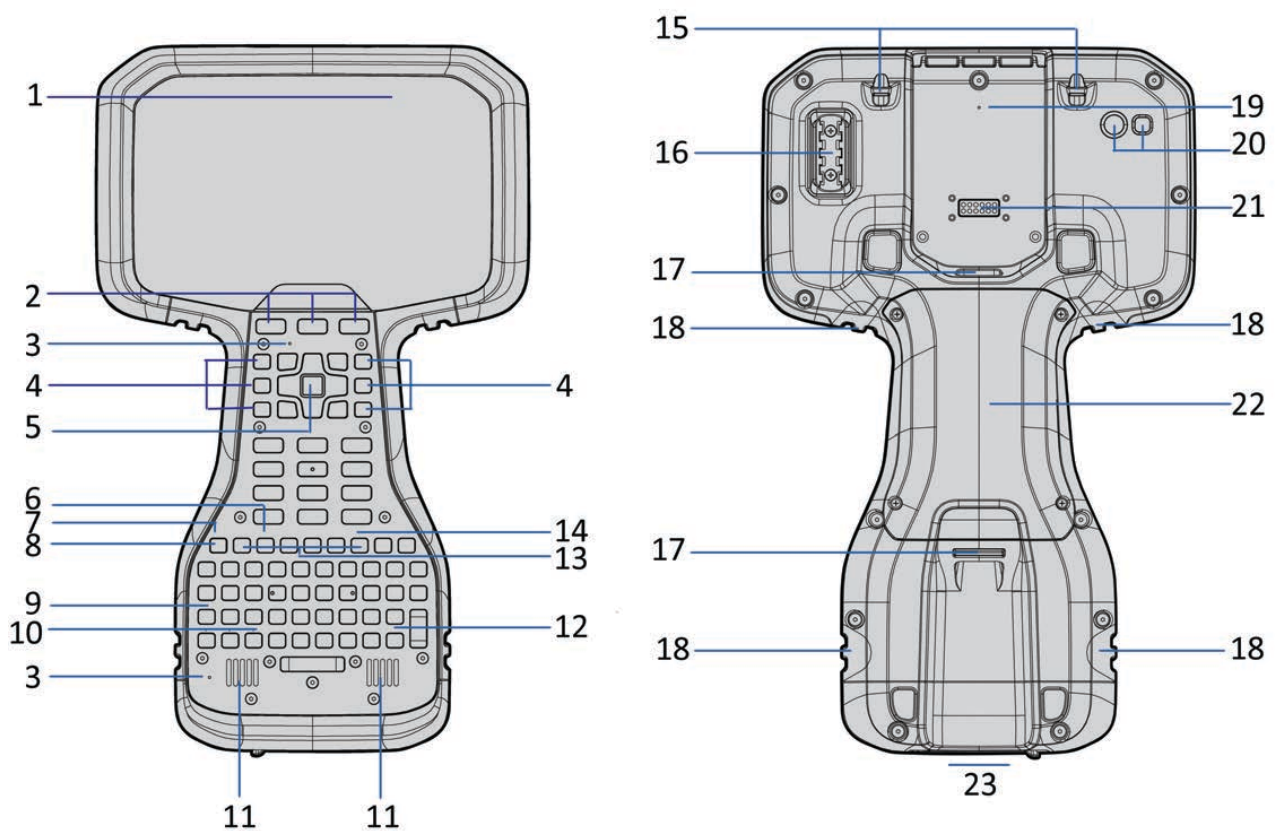

- | | | | |
|----|--------------------------------------|----|---|
| 1 | Ambient light sensor | 13 | Function Keys (F7 - F12) |
| 2 | Android keys | 14 | Cursor lock LED |
| 3 | Microphone (x2) | 15 | Stylus tether points |
| 4 | Function keys (F1 - F3, F4 - F6) | 16 | Stylus holder |
| 5 | OK and directional keys | 17 | Pole mount latches (x2) |
| 6 | CAPS lock LED | 18 | Handstrap connector points (x4) |
| 7 | Battery charging LED | 19 | Gore Vent: DO NOT COVER! |
| 8 | Power key | 20 | Camera & camera flash |
| 9 | Shift LED | 21 | Trimble EMPOWER module bay |
| 10 | LEDs left to right; Fn, Ctrl, Search | 22 | Cover for SIM card slot |
| 11 | Speakers (x2) | 23 | USB-C port, bottom of device under port cover |
| 12 | AGr LED | | |

Setting up the device

- ▶ Inserting a MicroSIM card (optional)
- ▶ Tethering the stylus
- ▶ Installing a screen protector
- ▶ Attaching the pole bracket (optional)
- ▶ Attaching the handstrap
- ▶ Attaching an EMPOWER module (optional)

This section tells you how to set up your TSC5 controller before you start using it.

Inserting a MicroSIM card (optional)

If your TSC5 controller is equipped with a 4G LTE modem, you will need a data plan and microSIM card from your local cellular service provider to use cellular data. If you are unsure, check with your mobile operator. See [Working with mobile broadband, page 70](#) for more information.

 **CAUTION** – Do not replace the SIM card while outdoors. Water, dust, dirt or debris may collect inside the SIM card bay causing performance issues.

 **CAUTION** – The SIM card door can be damaged if handled carelessly or if sharp tools are used to open the door. Take care not to twist or warp the door when opening or closing it.

1. If the device is on, turn it off; press-hold the **Power** key, then tap **Power Off**.
2. Using the Philips screwdriver, loosen the 4 screws to remove the cover from the back of the device.

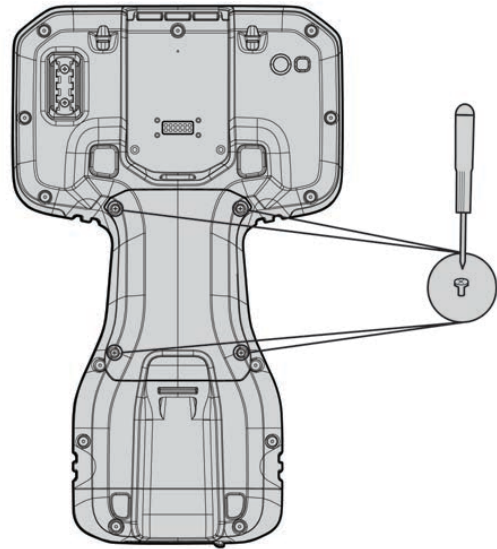

3. Pry open the MicroSIM card door using a coin or the tool located on the stylus tether as shown; do not remove the door completely.
4. Slide the microSIM card into the slot in the orientation shown on the microSIM door.
5. Close the microSIM door, making sure it clicks shut.
6. Replace the cover and tighten the 4 screws using the Philips screwdriver.

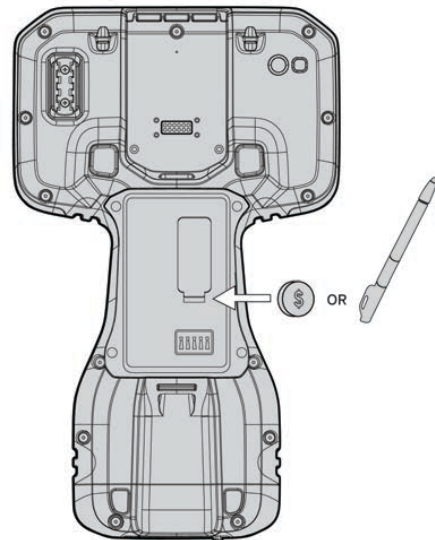

Tethering the stylus

Attach the stylus to the device to prevent accidentally dropping the stylus. The stylus is supplied with one end of the tether cord pre-looped to the stylus. You can attach the stylus to the left or the right side of the device. To tether the stylus to the device:

1. Take the loose end of the tether cord and push it through the tether point.
2. Feed the stylus through the loop and pull tight.
3. Place the stylus in the stylus dock (shown top left in the image below) to store it when not in use.

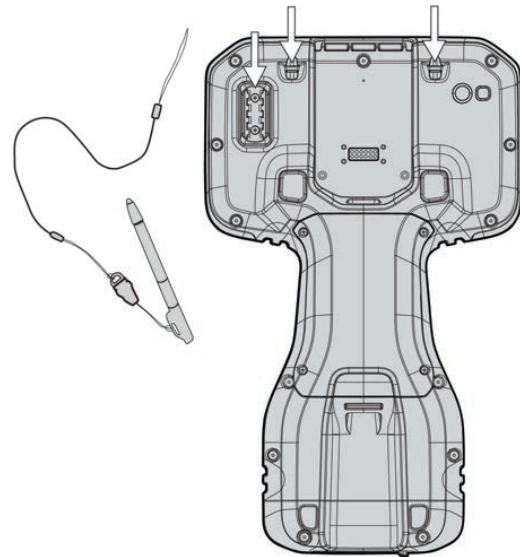

Installing a screen protector

The TSC5 controller is fitted with a mechanically strengthened glass touchscreen which is highly resistant to abrasion and impact damage.

However to ensure maximum protection, it is recommended that you use a Trimble-approved glass TSC5 controller screen protector.

To install a screen protector:

1. Place the device on a clean, flat surface. Make sure your hands are clean.
2. Clean the touchscreen with the supplied alcohol wipe.

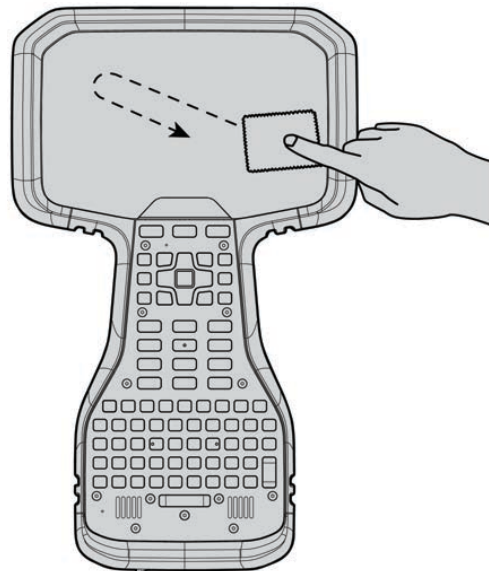

3. Polish and dry the screen with the lint-free cleaning cloth supplied.

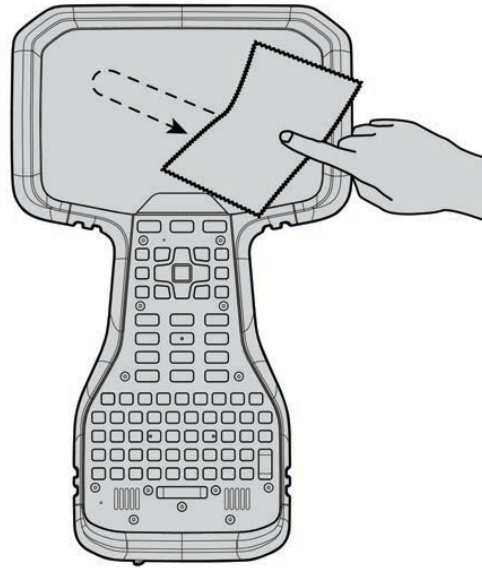

4. Remove any dust specs with the supplied dust sticker.

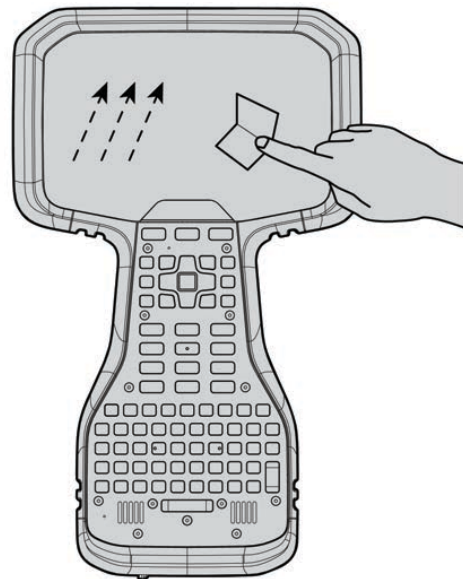

5. Remove the protective film from the screen protector.

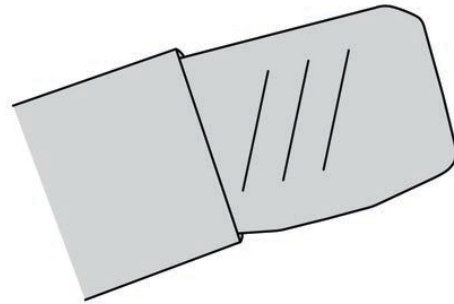

6. Align the screen protector with the bottom of the glass display. Use the TSC5 controller badge at the top of the keyboard as a guide, leaving a small, evenly spaced gap around all edges. The screen protector should line up evenly with the TSC5 controller label and the edges of the device.

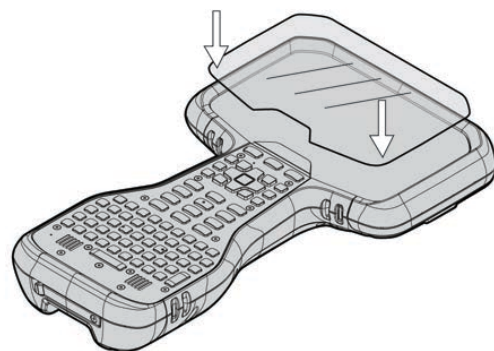

7. Carefully lay the screen protector down on the screen. If you make a mistake and the glass looks off-center, you can gently lift the screen protector up and realign it. Then, once the protector is on the screen, give it a soft press in the center and allow the adhesive surface to grip to the screen naturally.
8. If there are any bubbles remaining, use the cloth provided to gently smooth them toward the edges of the screen protector.

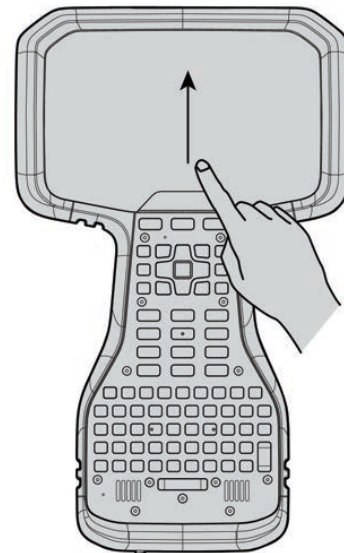

For more information on where to purchase the correct screen protector for your device, contact your local Trimble reseller.

Attaching the pole bracket (optional)

An optional accessory for the TSC5 controller, the pole mount consists of three parts:

- the TSC5 controller-facing part. This is a custom bracket mount which attaches to the TSC5 controller.
- The adjustable arm.
 - One end screws onto the custom TSC5 controller bracket mount, and the other end includes a connector that is compatible with other Trimble mounting products.
 - The arm can be set up for left or right hand usage. To switch it from one side to the other, unscrew the black screws in the cradle plate where the device sits, rotate the cradle plate, then screw it back into place.

NOTE – This part can also be used with a Trimble TSC7 controller.

- The pole-facing part.
 - One side attaches to the connector on the adjustable arm, and the other side includes the pole clamp.
 - The pole-facing part is compact, so that it fits into a 10 cm (4") pipe for storage.
- NOTE** – This part can also be used with a Trimble TSC7 controller and other Trimble products.



The TSC5 controller bracket mount “snaps” easily onto the controller.

To attach the bracket to the TSC5 controller:

1. Screw the adjustable arm onto the bracket mount.
2. To install the bracket onto the TSC5 controller, place the bracket hook into the mount point directly above the battery door on the controller. Then, pull down on the spring mechanism on the bottom of the bracket mount and push firmly into the controller to snap into place.

To remove the bracket mount from the TSC5 controller, pull down on the spring mechanism and lift up to remove.

When the pole bracket mount and adjustable arm are attached to the TSC5 controller, it “snaps” easily into the cradle of the pole clamp assembly.

To attach the TSC5 controller onto the pole mount, place the connector on the adjustable arm into the pole clamp and then push it firmly into the snap lock.

To remove the TSC5 controller from the pole clamp, on the back of the locking mechanism, pull the lever to release the TSC5 controller.

Attaching the handstrap

Attach the handstrap to the left or the right side of the device, according to your personal preference. To ensure a good fit:

1. Thread one end of the handstrap ribbon through the top handstrap slot; thread from the center of the device toward the top of the device.
2. Pull the end of the ribbon back towards the center of the handstrap and feed it up, over, and down through the lock buckle on the handstrap and pull it tight.
3. Thread the ribbon at the other end of the handstrap through the bottom handstrap slot; thread from the center of the device toward the bottom of the device.
4. Pull the end of the ribbon back towards the center of the handstrap and feed it up, over, and down through the lock buckle on the handstrap and pull it as tight as is comfortable for your hand.

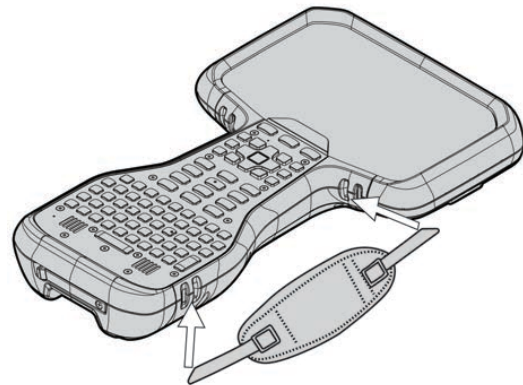

If required, use a small blunt tool to push the ribbons through the handstrap slots on the device. Do not use a sharp tool.

When using the handstrap, the device should sit firmly in the hand.

Attaching an EMPOWER module (optional)

NOTE – Before you install or remove a module from the device, make sure the device is powered off or in Sleep state. For more information, see [About Sleep state, page 41](#).

NOTE – You need to re-calibrate the compass after installing or removing the EMPOWER module. For more information, see [Calibrating the compass, page 73](#).

To attach an EMPOWER module to the TSC5 controller:

1. Hook the EMPOWER module onto the back of the device, ensuring that the slots on the top of the device line up with those on the EMPOWER module.
2. Using the Phillips #1 screwdriver, tighten the 2 captive screws at the bottom of the EMPOWER module to secure the module in place. Do not overtighten the screws.

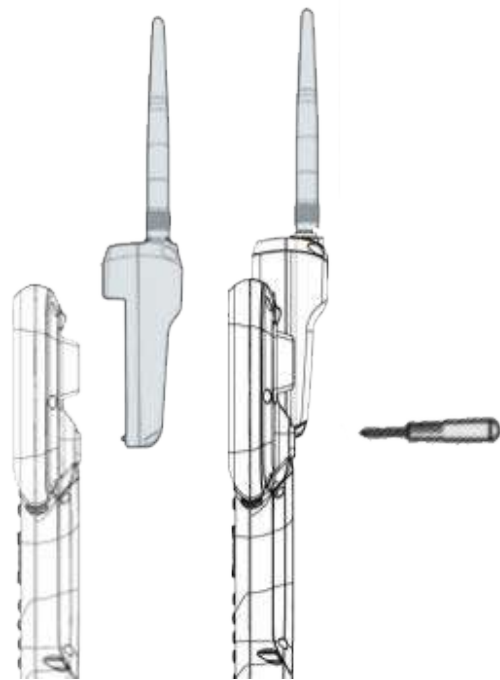

Getting started: basic operation

- ▶ Shelf mode: charging the device for the first time
- ▶ Turning the device on, off
- ▶ Checking the battery charge levels and LED status
- ▶ Charging the batteries
- ▶ Making your battery last longer
- ▶ Using the touchscreen
- ▶ Display settings: adjusting the backlight
- ▶ Display settings: screen auto-rotation
- ▶ Using the onscreen keypad
- ▶ Using a USB or Bluetooth mouse

This section covers some explains some basic features to get you started using your TSC5 controller.

When you start your device for the first time, the Android operating system takes you through some basic setup steps; follow the instructions on the screen.

For more details on setting up and using the Android operating system, see [Using the Android operating system, page 58](#) or go to the [Android 10 website](#).

Shelf mode: charging the device for the first time

The TSC5 controller ships in a low power Shelf mode to conserve power. While in Shelf mode, the device will only turn on when a charging source is connected. Once the device is plugged into a charging source and powered on, it is taken out of Shelf mode.

The internal battery is charged using the USB-C port directly on the bottom of the device. It takes approximately 3.5 hours to fully charge the device's internal batteries from an empty state using the AC adapter and USB-C to USB-C cable included in the packout.

1. Connect the appropriate international plug adapter for your region to the AC adapter.
2. Connect one end of the USB-C to USB-C cable to the USB-C port located on the AC adaptor.
3. Connect the other end of the USB-C cable to the USB-C port on the TSC5 controller.
4. Plug the power supply into an electrical outlet and charge for 3.5 hours.

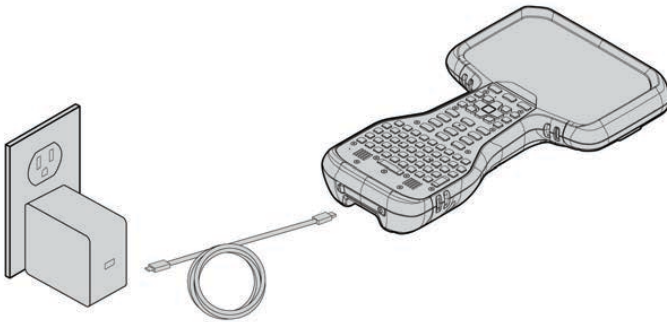

NOTE – It may take longer to charge the batteries if you use third party AC adapters.

Using Shelf mode

To put the device back into Shelf mode for shipping or long term storage, go to **Settings / Battery / Advanced / Shelf Mode Enable**, and select **OK**. Alternatively, press-hold the **Power** key for a couple of seconds to access the option to place the device in Shelf mode. The device will shut down, and will require a charging source as described above to turn on again.

Turning the device on, off

The first time you turn the device on [from Shelf mode](#):

1. Make sure the device is plugged into a charging source.
2. Press-hold the **Power** key until the **Powered by Android** boot screen appears.

NOTE – If this is not the first time you are turning on the device, and if a PIN, password, or pattern has been set, you must swipe up on the touchscreen to enter the PIN / password / pattern.

The first time you use your TSC5 controller, the Android operating system will guide you through some basic setup steps.

For normal use when the device is not in Shelf mode, to turn on the TSC5 controller, the device does not need to be plugged into a charging source:

1. Press-hold the **Power** key until the **Powered by Android** boot screen appears.
2. Swipe up on the touchscreen to enter a PIN, password, or pattern, if one has been set.

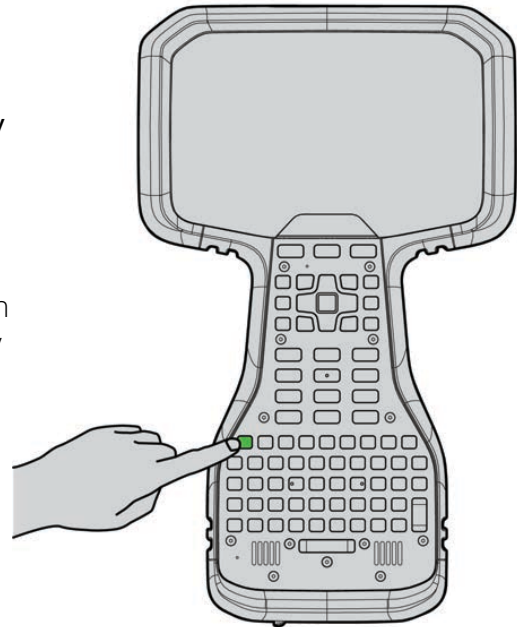

About Sleep state

If the TSC5 controller is unplugged and stationary for one minute (default setting), the screen turns off and the device goes into a power-saving Sleep state, called Android Doze. Doze reduces battery consumption by deferring background CPU and network activity for apps when the device is unused for long periods of time. App Standby defers background network activity for apps with which the user has not recently interacted. The device exits Doze mode and resumes normal activity as soon as the device is moved, the screen is turned on, or when connected to a charger.

To force your device to Sleep, briefly press the **Power** key.

To set the screen turn-off time, go to **Settings / Display / Advanced / Screen timeout**, and select 2, 5, 10 or 30 minutes.

Waking and unlocking the device

To wake the screen when it has turned off, briefly press the **Power** key.

Depending on your security settings, your device may be locked. To unlock it, swipe up on the screen then enter your PIN, password, or pattern.

Restarting the device

To restart your device, press-hold the **Power** key until the **Power** menu appears, then tap **Restart**.

Turning off the device

To turn off the device, press-hold the **Power** key until the **Power** menu appears, then tap **Power Off**.

Checking the battery charge levels and LED status

The TSC5 controller is powered by internal batteries which are not removable.



It takes approximately 3.5 hours to charge the TSC5 controller internal batteries from an empty state using the AC adapter and USB-C to USB-C cable included in the packout.

It may take longer if you are using your device for power-intensive activities, for example using GNSS or processing a lot of data while you are charging it.

NOTE – It may take longer to charge the batteries if you use third party AC adapters.

LED charging status

An LED on the keyboard (above the **Power** key) shows the charging status.

-  Green: fully charged.
-  Amber: charging normally.
-  Red: battery charging error. It can take the device approximately 30 seconds to recognize a bad battery and indicate a charging error.

Checking the charge level of the batteries

You can check the charge level of the batteries from the **Status** bar (top right corner of the screen).

To access the detailed battery charge information for the batteries, swipe down from the top of the display, tap the **Settings** icon, then tap **Battery**.

Turn on **Battery percentage** to display the battery charge level on the **Status** bar.

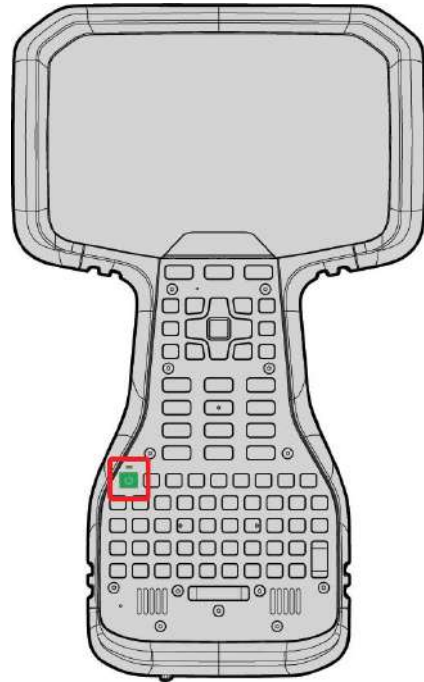

Charging the batteries

The batteries are charged using the USB-C port directly on the bottom of the device.

1. Connect the appropriate international plug adapter for your region to the AC adapter.
2. Connect one end of the USB-C to USB-C cable to the USB-C port located on the AC adaptor.
3. Connect the other end of the USB-C cable to the USB-C port on the TSC5 controller.
4. Plug the power supply into an electrical outlet.

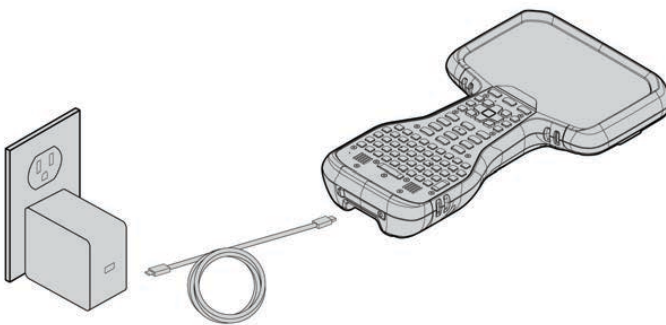

It may take longer to charge the batteries if you are using your device for power-intensive activities, for example using GNSS or processing a lot of data while you are charging it.

Making your battery last longer

The Android 10 operating system includes a number of features to help you get the maximum run time out of your battery. Here are some practical suggestions that you can do to maximize the operating time of the battery:

- **Use Battery Saver mode** to help the device's battery last longer when it is running low. This mode turns off or restricts background activity, some visual effects and other high-power features to extend battery life. To turn on **Battery Saver** mode, swipe down from the **Status** bar and tap the **Battery Saver** icon, then tap **TURN ON**. When **Battery Saver** mode is on, the battery icon in the **Status** bar is red.

NOTE – Battery saver turns off automatically when your device is charging.

NOTE – Battery saver does not stop position data coming through from location services.

- **Keep Battery optimization on.** To have apps use your device's battery only when they need to, keep **Battery optimization** on for all apps. **Battery optimization** is on by default.

To specify battery optimization for any apps, go to **Settings / Battery**, then tap  / **Battery usage**. Tap on any app in the list to view options. Under **MANAGE BATTERY USAGE**, you can view or select **Background restriction** and **Battery optimization**.

- **Background restriction.** To save battery charge, tap **Background restriction** and then select **RESTRICT**. This stops the app from using battery charge in the background. Note that this may cause apps to work improperly and cause delayed notifications.
- **Battery optimization.** Most apps will have the **Optimizing battery use** setting enabled by default. Tap this option to view apps that are not optimized. Select **All apps** from the dropdown next to **NOT OPTIMIZED** to view all apps. Select an app from the list to turn **Battery optimization** on or off. Turning off is not recommended, as it may drain the battery more quickly as the app will no longer be restricted from using background battery.
- **Stretch a low battery's power.** To help a dying battery last until you can charge it, first turn on **Battery saver** mode. Often, battery saver is all you'll need for a low battery's power to last until you can get to a charger. Stretch your remaining battery power with temporary changes to your settings/usage.

TIP – Turn the features back on when you have charged the battery.

- **Avoid high-drain activities;** for example, heavy screen use, heavy data processing.
- **Turn off the wireless radios** when not using them to limit connectivity; for example, turn on Airplane mode, turn off Bluetooth. See [Using wireless networks, page 67](#).

- **Limit location data**; for example, turn on GPS battery saving mode, turn off Location services.
- **Limit automatic syncing**; for example, turn off auto-sync for your Google account, turn off auto-sync for certain Google apps.
- **Unplug USB devices**. Many USB devices use power just by being connected. If you use a USB flash drive, unplug it when you are not using it.
- **Turn off EMPOWER modules** if you will not be using them for a prolonged period; see [Disabling and enabling modules in the EMPOWER Hub, page 82](#).
- **Decrease the display brightness** to the lowest comfortable level. See [Display settings: adjusting the backlight, page 47](#) for more information.
- **Turn off screen rotation**. See [Display settings: screen auto-rotation, page 48](#) for more information.
- If you don't work in low light settings, **disable the keypad backlight**. Go to **Settings / System / Languages & input / Physical keyboard / Built-in Keyboard**. Tap the slider next to **Enable** to disable the keyboard backlight.
You can also adjust the brightness of the keyboard backlight by moving the **Backlight brightness** slider left or right.
- **Turn off the handheld** when you are not using it. See [Turning off the device, page 42](#).
- **Reduce the length of time before the operating system turns off the display**. To further save battery power, ensure the device settings are configured to turn off the screen when you haven't used it for a length of time. See [About Sleep state, page 41](#).



For more information on making your battery last longer, refer to the help topic [Get the most life from your battery](#) on the [google.com](#) support site.

Using the touchscreen

Your TSC5 controller can be easily operated with the touchscreen (using your fingers, a stylus, or a glove), a mouse, an onscreen keypad, or the full built-in keyboard. You can easily switch between any of these input methods.

Switching between finger, glove and stylus mode

To select or switch between Finger, Glove, and Stylus mode:

1. Swipe down on the **Notifications** bar at the top of the **Home** screen.
2. Tap the touch mode icon to cycle through Finger  / Stylus  / Glove  modes or swipe down a second time to view the icon and text and cycle through the 3 modes.

You can also open the **Touch Panel Mode** settings to select or switch between Finger, Glove, and Stylus mode:

1. Swipe down on the **Notifications** bar at the top of the **Home** screen then swipe down again and tap the **Settings** icon.
2. Select **Display** then tap the **Advanced** dropdown.
3. Select **Touch Panel Mode** and choose between Finger, Stylus or Glove Mode.

When using the device in the rain, Trimble recommends that you use Finger mode, with a screen protector installed.

Using the stylus



Trimble recommends that you use the TSC5 controller stylus accessory. There are many other capacitive touch styli available that will work with the TSC5 controller as long as they have a rubber tip; however the stylus available as an accessory is tuned for the TSC5 controller display and it fits into the stylus holder. Trimble offers no guarantee that other styli will work.





Take notes, draw, navigate, and mark up documents in your apps using the stylus that comes with your device.

To make a selection, tap the screen once on the item you want to select.

To display a right-click sub-menu, tap-hold an item on the screen, then tap the required menu item.

Main touchscreen input gestures and functions supported on the TSC5 controller

	Tap once on the screen / tap to type.	Select, open or execute the action of what was tapped on your device. To enter text, tap where you want to type; use the onscreen keypad to type.
	Press-hold your finger or the stylus down for a few seconds.	Shows a menu with options related to what you're doing (like right-clicking with a mouse). On the pop-up menu that appears, tap the action you want to perform.
	Double tap on something.	Tap quickly twice on a webpage, map, or other screen to zoom. Double-tapping after pinching to zoom in some apps, such as Browser, reflows a column of text to fit the width of the screen

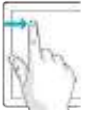
	Slide / swipe your finger or the stylus across the screen.	Scrolls through what's on the screen. Quickly move your finger across the surface of the screen, without pausing when you first touch it, to scroll a page or a list up or down. Scrolls vertically or horizontally. Swipe a Home screen left or right to see your other Home screens.
	Drag your finger or the stylus across the screen.	Hold your finger or the stylus on an item for a moment and then, without lifting your finger/the stylus, move across the screen until you reach the target position. <ul style="list-style-type: none"> • Drag in a list to select multiple items. • Drag items on the screen to reposition them.
	Pinch / stretch: pinch your thumb and forefinger together or move them apart.	Zooms in or out of a website, map, or picture.
	Rotate: put two or more fingers on an item and then turn your hand.	Rotate the screen left or right in apps that support it, such as Maps.
	Swipe down from the top of the screen.	Displays the Notifications bar. Swipe up to close the Notifications bar.
	Swipe in from the left or right edge of the screen.	Left edge swipe opens Google search. Right edge swipe opens other Home screens.

Display settings: adjusting the backlight

The TSC5 controller is equipped with a high brightness outdoor readable display. You can easily increase the brightness of the display to increase the readability of the device in bright sunlight conditions, or turn down the brightness to help conserve battery power when working indoors or in dull conditions. You can also set the device to automatically adjust the backlight power depending on the ambient light conditions.

Configuring Adaptive brightness

Adaptive brightness is on by default. It uses the ambient light sensor on the device's screen (see [Parts of the TSC5 controller, page 30](#)) to adjust your screen brightness depending on the amount of light around you.

To adjust the backlight settings, and turn Adaptive brightness off / on:

1. Open the **Settings** app .
2. Tap **Display**.
3. Tap the setting that you want to change.

Manually adjusting the backlight brightness

1. Swipe down from the **Status Bar** at the top edge of the screen to view the **Quick Settings** bar.
2. Slide the backlight slider  left or right to adjust the brightness.





NOTE – You can manually adjust your brightness level while Adaptive brightness is on.

TIP – You can also access the backlight slider by pressing **Fn + 7**.

Display settings: screen auto-rotation

The TSC5 controller is equipped with orientation sensors that can detect if your device is in portrait or landscape orientation. The operating system can automatically adjust the display to match your device orientation, or you can lock the orientation.

Swipe down from the top of the screen to display the **Quick Settings** bar.

- If auto-rotate is turned off, the auto-rotate icon  is not visible; **Portrait** or **Landscape** will be displayed instead. Tap to turn on auto-rotate .
- If auto-rotate is turned on, the auto-rotate icon  is visible. You can:
 - Tap  to toggle auto-rotate Off.
 - Lock the orientation. Orientate the device to **Portrait** or **Landscape**, then tap  to turn off auto-rotate and lock the device in the selected orientation.

Using the onscreen keypad

You can type on the device using a keypad (virtual keyboard) on the touchscreen. The onscreen keypad is disabled by default. To turn it on:

1. Go to **Settings / System / Languages & input / Physical keyboard**.
2. Next to the **Show virtual keyboard** setting, tap the slider to turn it on.
3. When you tap in a text field on the screen, the onscreen keypad will appear.

You can still use the physical keyboard while the virtual keyboard setting is on.

Using a USB or Bluetooth mouse

You can attach a physical keyboard, mouse and other peripherals to your TSC5 controller via USB or Bluetooth. For more information see [Using accessories and connecting to other devices, page 75](#).

Using the integrated keyboard

The TSC5 controller has a full built-in QWERTY keyboard. The keyboard is similar in most ways to a standard PC keyboard; there are some differences due to the keyboard's small physical size, and some special features have been added to support users' specific requirements.

This section covers how to use the keyboard, and describes the special / non-standard functionality of the keyboard and the associated utilities.

- ▶ [About the keyboard controller firmware](#)
- ▶ [Main keyboard keys](#)
- ▶ [Configuring built-in keyboard settings](#)
- ▶ [Keyboard status LEDs](#)

About the keyboard controller firmware

To check the keyboard controller firmware version and keyboard type, go to: **Settings / System / Languages & input / Physical keyboard / Built-in Keyboard / About**.

The keyboard controller manages the [sticky key operation of all modifier keys](#).

Main keyboard keys

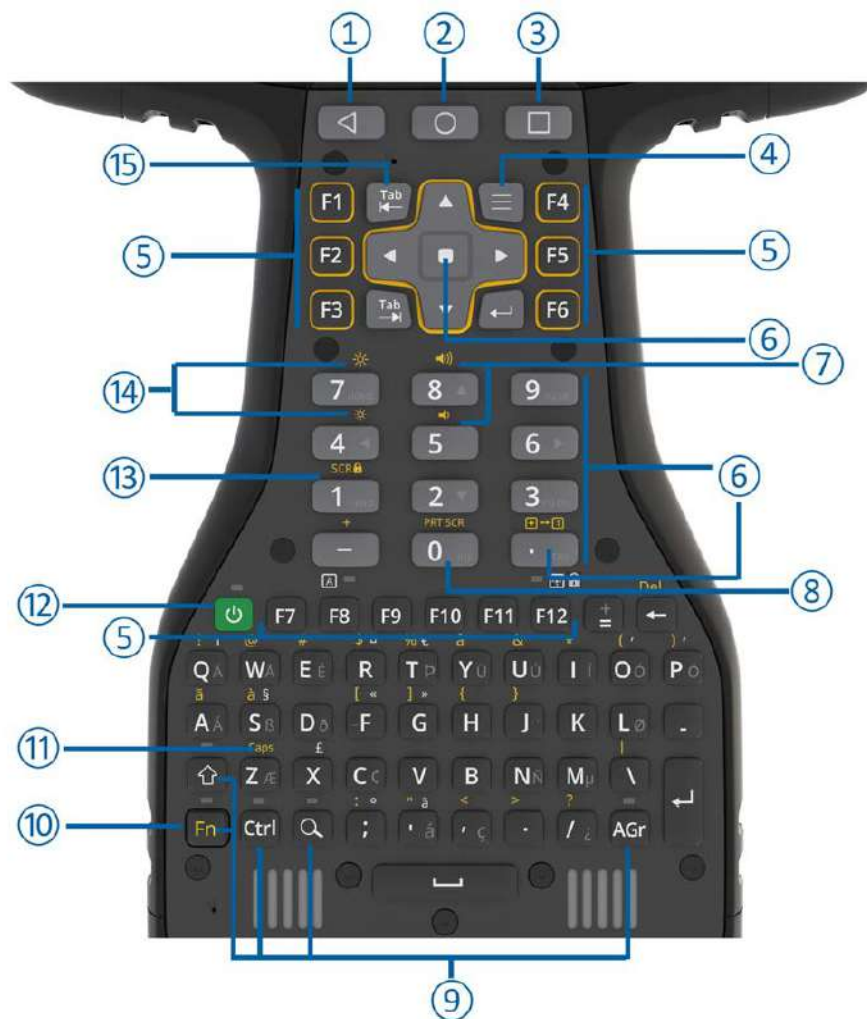

- 1 Android Back key
- 2 Android Home key
- 3 Android Overview key
- 4 **App Menu:** App-specific, this launches the menu for the active app; it performs the same function as the  menu key that most apps have (giving options for help, about, exit, etc.). It is supported in Trimble Access, but for 3rd party apps it may not do anything.
- 5 **Function keys F1-F12**
These can be configured in the Trimble software according to your requirements. Refer to the Trimble software documentation.

6 Numeric Keypad, Numeric Keypad Enter key, and Cursor Lock / Num Lock key:

- The **Numeric Keypad** is locked to **Num Lock** by default; the 0 to 9, decimal point ('.') and minus ('-') keys perform the same as the numeric keyboard on a standard PC keyboard.
- The **Numeric Keypad Enter** key performs the same as the numeric keyboard Enter key on a standard PC keyboard.
- **Cursor Lock / Num Lock key.** By default, the numeric keypad is locked in **Num Lock** (the LED status icon below the key is OFF).

To turn off Num lock and turn on Cursor lock, press-hold the yellow **Fn** key and press the . key (the decimal point) to change the numeric keypad to a Cursor Navigation state. In Cursor Navigation state, the keys function according to the "key+Shift" behavior (Home; End; Page up; Page Down; left, right, up, or down arrow; Insert; and Delete.)

When in Cursor Navigation state, the LED status icon below the key is ON (green).

7 Master Volume keys: Use to adjust the device's speaker volume.

- **Fn+8** = Volume up
- **Fn+5** = Volume down.

8 Print Screen (Fn+0). Capture a screenshot of what is currently visible on the screen.

Screenshots are saved to the **Files / Images / Screenshots** folder and can also be accessed under **Photos / Screenshots**.

TIP – You can also Print Screen by holding down the Power key and tapping Screenshot.

9 Modifier Keys: Fn, Shift, Ctrl, and AGr

NOTE – The **Search** key () is used as a non-modifier key to open the Android Search function. You can make it non-sticky by turning this option Off. See [Modifier keys and Sticky keys: modes and settings, page 54](#) for more information.

The modifier keys are keys that modify the action taken when other keys are pressed while the modifier key is held down. Modifier keys can be used in combinations with more than one key pressed at the same time.

To make the keyboard easier to use the modifier keys can be configured as **sticky keys**. When sticky keys are enabled the modifier keys “stick down” when pressed so that you do not need to press-hold a modifier key while you press the other key. See [Modifier keys and Sticky keys: modes and settings, page 54](#) for more information.

10 **Fn Key** (Function Select key). Use the **Fn** key to access a key's alternate function, as printed above the key.

- If sticky keys are not enabled, press-hold the **Fn** key and press the other required key.
- If sticky keys are enabled you do not need to hold the **Fn** key while pressing the other key.

See [Modifier keys and Sticky keys: modes and settings, page 54](#) for more information.

11 **Caps Lock = Fn+Z**: locks the keyboard alphabetic keys to capital letters.

12 **Power key**. Turn the screen on / off. Press-hold the Power key for a couple of seconds to quickly access settings to power off or restart the device, capture a screenshot or place the device into [Shelf mode \(page 40\)](#).

13 **Screen Lock = Fn+1**. Use to temporarily disable the touchscreen to clean the display. Press any key to unlock the touchscreen.

NOTE – In this mode the Notification bar is still accessible.

14 **Screen Display Brightness**: Adjust the display's backlight brightness:

- **Fn+7** = brighter
- **Fn+4** = dimmer

NOTE – You can also set the display brightness to adjust automatically when the ambient lighting conditions change. See [Display settings: adjusting the backlight, page 47](#).

- 15 **Back Tab key** The back tab key performs the same function as pressing the **Shift** key and the **Tab** key. For many applications this will move the focus to the previous control in the sequence, as opposed to the **Tab** key which moves the focus to the next control.

For applications that use the **Tab** key for text entry, the **Back Tab key** typically performs the same as the **Tab** key.

Configuring built-in keyboard settings

You can configure some keyboard behaviors under **Settings / System / Languages & input / Physical keyboard / Built-in Keyboard**.

Use the Built-in Keyboard settings to check settings or make changes to some of the built-in keyboard behavior. Use the Android toggle to Enable/Turn On (slide to the right) or Disable/Turn Off (slide to the left). Details for each setting are covered below.

Built-in keyboard backlight

The built-in keyboard is equipped with a backlight that makes it easier to use in dimly lit areas. The backlight is activated when you press a key; it stays on for a while and then turns off to conserve power. You can manually turn off the backlight or adjust its brightness.

To edit the backlight behaviors, go to **Settings / System / Languages & input / Physical keyboard / Built-in Keyboard / Backlight** and configure as required:

- **Enable.** This is On by default. If you don't work in low light settings, turn Off to completely disable the backlight and save battery power.
- **Timeout .** Set the Timeout value to determine how long the backlight stays on when no keys are pressed.
- **Automatic Mode.** When set to:
 - Off, the backlight is always enabled . This is the default setting.
 - On, the device's ambient light sensor is used to keep the backlight from turning on in well lit areas.
- **Backlight brightness.** Move the slider to adjust the brightness of the backlight (right = brighter, left = dimmer). Brighter settings consume more power than dimmer settings.

Modifier keys and Sticky keys: modes and settings

Use Modifier keys to modify the action of another pressed key, while you press-hold the modifier key. Modifier keys can be used in combinations, with more than one modifier key pressed at the same time.

The modifier keys are:

- the **Fn** key
- the **Shift** () key
- the **Ctrl** key
- the **AGr** key

Since the device is normally hand-held, it can be difficult to press multiple keys on the built-in keyboard at the same time. To make the keyboard easier to use, you can set the modifier keys to be Sticky keys.

NOTE – You can also set the **Search** key  to be a Sticky key.

When Sticky keys are enabled, the modifier keys “stick down” when pressed so that you do not need to press-hold a modifier key while you press the other key(s), allowing multiple key combinations to be pressed sequentially.

To configure Modifier / Sticky key behavior, go to **Settings / System / Languages & input / Physical keyboard / Built-in Keyboard / Sticky Keys**. If Sticky key behavior is off, move the **Sticky modifier keys** slider to the right to turn on Sticky key behavior.

- **On (default)** = Sticky key behavior is enabled. Modifier keys “stick down” when pressed, and stay active until you press a non-modifier key.
- **Off** = Sticky key behavior is disabled. To access modified key functions, you must press-hold the required Modifier key and then press the other key you want. E.g. press-hold **Shift** then press an alpha key to access the capital letter.

The different Sticky key modes / settings and behavior of the modifier keys when Sticky key behavior is enabled is described below.

- The **Search** key is used as a non-modifier key to open the Android Search function. You can make it non-sticky by turning this option Off.
 - **Off (default)**: Search key is not a sticky key. Because the Search key is sometimes used in a non-modifier fashion this control allows the Search key to not be sticky while the other keys remain sticky.
 - **On**: Search key is a sticky key.
- **Lock modifier keys** when pressed twice in quick succession. You can set a modifier key to be locked down indefinitely by turning this setting On; when you then press a modifier key twice, it locks down until you press the key a third time.
 - **Off (default)**: Modifier keys are released when pressed two times in quick succession. Normal Sticky keys mode: Temporarily latch modifier key when pressed.

Pressing and releasing a modifier key one time latches the modifier key state down until a non-modifier key is pressed at which point the modifier key is released.

- **On:** Modifier keys are locked down when pressed twice in quick succession (press a third time to release). Pressing and releasing a modifier key one time latches the modifier key state down until another non-modifier key is pressed at which point the modifier key is released. Pressing and releasing a modifier key two times in quick succession locks the modifier key state down until it is pressed and released a third time.
- **Play sounds** when modifier keys are pressed. Plays a sound when sticky keys are locked down or released to make it easier to determine the locked state of the modifier keys.
 - **Off (default):** No sound when sticky keys are pressed or released.
 - **On:** Play a sound when a modifier key is latched down, locked down, or sticky keys are pressed or released.

Keyboard status LEDs

There are 8 LEDs on the keyboard, including five Modifier / Sticky key LEDs. The Sticky key LEDs represent the sticky state of the Modifier key it is located above.

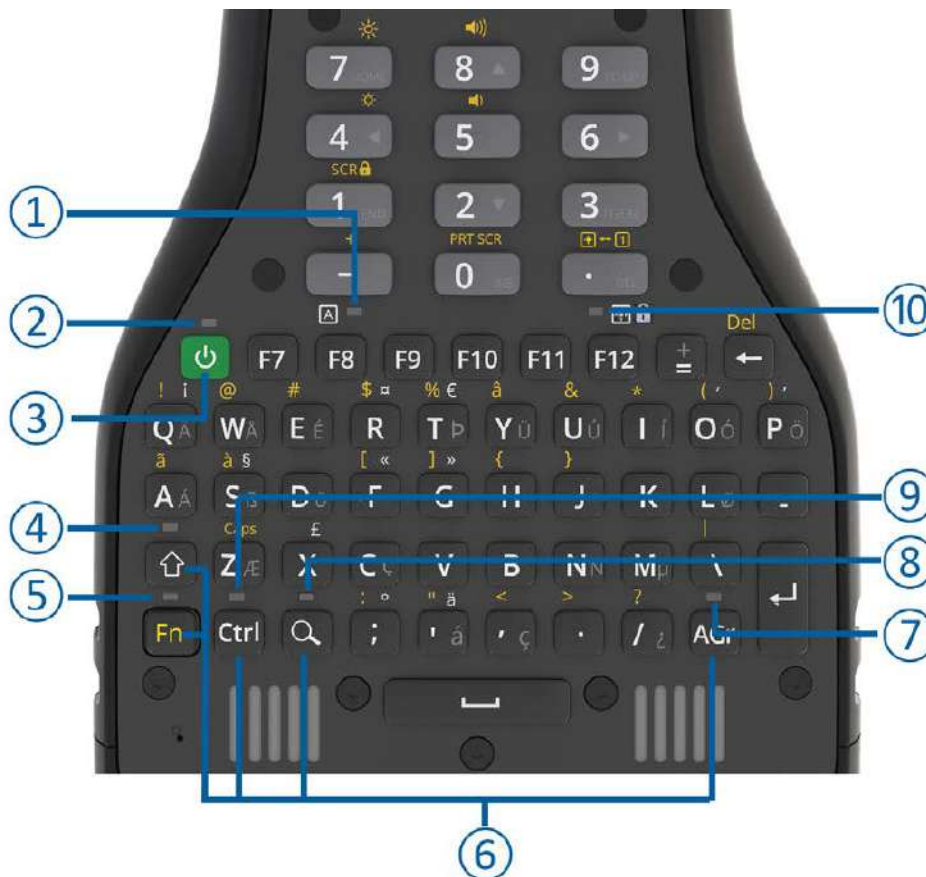

The different LED states are:

	No LEDs On	None of the Modifier keys are set as "sticky".
1	Caps Lock LED	ON: Caps locked. OFF (Default): Caps unlocked.
2	Battery Charging LED	See Checking the battery charge levels and LED status, page 42
3	Power key	
4	Shift key LED	ON= the Shift key is set as "sticky".
5	Fn key LED	ON= the Fn key is set as "sticky".
6	Modifier keys	Shift, Fn, Ctrl, Search, AGr
7	AGr key LED	ON= the AGr key is set as "sticky".
8	Search key LED	ON= the Search key is set as "sticky".
9	Ctrl key LED	ON = the Ctrl key is set as "sticky".
10	Cursor / Num Lock LED	OFF = Num Lock is on (this is the default) and Cursor Navigation mode is off. The numeric keyboard performs the number functions. ON = Cursor Lock is set as "sticky"; the Cursor Navigation mode is on, and the Numeric function is off (the numeric keyboard performs the cursor navigation function). To turn off Cursor Navigation mode and turn on the Numeric function, press Fn + "." .

See [Modifier keys and Sticky keys: modes and settings, page 54](#) for more information.

Using the Android operating system

- ▶ [Using Accounts](#)
- ▶ [The Android interface](#)
- ▶ [Using the pre-installed Google apps and other apps](#)

This section introduces some basic information on using the Android 10 operating system on the TSC5 controller. For additional information, go to the [Android 10 website](#).

NOTE – The TSC5 controller ships in Shelf Mode and must be plugged into external power to power it on for the first time. See [Shelf mode: charging the device for the first time, page 40](#).

Press the Power key to turn on the TSC5 controller. The Android operating system will guide you through the setup process. The first time you use the TSC5 controller, you'll be prompted to set up a Wi-Fi network and a Google Account to use with your device.

Using Accounts

You can sign up for a Google Account or use one that you already have. You already have a Google Account if you use an email address to sign in to any Google product, for example: Gmail, YouTube, Google Play, AdWords, Google Apps, or any other Google product.

When you sign in with your Google Account, you'll have access to everything associated with your Google Account, like Gmail, calendar, contacts, apps you've purchased on Google Play, and other data associated with that account. If you have multiple Google Accounts, you can add the others later.

NOTE – If you have personal and work (Enterprise) Google accounts, refer to support documentation on the TSC5 controller product page for details on how to best set up your device.

 **WARNING** – Make sure you remember the password you use to sign into your device or else you won't be able to access it. Even if you do a factory reset, you will be required to enter the password you used to sign into this device.

Add a Google or other account

1. Open the **Settings** app.
 2. Tap **Accounts**.
 3. Tap **Add account**.
 4. Tap the type of account you want to add.
 - To add your Google Account, tap **Google**. When you sign in with a Google Account, the email, contacts, calendar events, and other data associated with that account automatically sync with your device.
 - To add a different personal account, tap **Personal (IMAP)** or **Personal (POP3)**. You'd generally choose these if you use an email program like Microsoft Outlook or Apple Mail.
- TIP** – [Learn how to use IMAP or POP3 with Gmail.](#)
5. Follow the on-screen instructions.
 6. If you're adding accounts, you may need to enter your device's pattern, PIN, or password for security.

You can add more accounts by repeating the steps above.

Remove a Google or other account

1. Open the **Settings** app.
2. Tap **Accounts**.
3. Tap the account you want to remove.
4. Tap **REMOVE ACCOUNT**.
5. If this is the only Google Account on the device, you'll need to enter your device's pattern, PIN, or password for security.

The Android interface

When you turn on your device, the main **Home** screen appears. The **Home** screen is the primary screen for accessing all of the TSC5 controller features on the device. You can add and customize **Home** screen(s) by adding app shortcuts and widgets (an at-a-glance view of the app's most important information). The main parts of the screen are:



- 1 **Notifications.** To see notifications, swipe down from the top of the screen with one finger.
Quick Settings (frequently used settings), are also located here.
To open all Settings, swipe down from the top of the screen a second time, then tap the **Settings** icon.
- 2 **Home** screen. To move between **Home** screens if you have more than one, swipe left or right.
On the main **Home** screen, tap **Google** at the top of the screen or say **OK Google** to search, send messages, ask for directions, or give other instructions.
- 3 Android **Back** key. Returns to the previous screen you were working in, even if it was in a different app. Once you back up to the **Home** screen, you can't go back any further.

- 4 Android **Home** key. Returns to the **Home** screen.
To get suggestions based on the screen you're currently viewing, tap and hold this button.
- 5 Android **Overview** key. Opens thumbnails of items you've worked with recently. To open an item, tap it. To remove an item, swipe it up or down.
- 6 **App shortcuts** to content inside apps.
- 7 **A widget** shows information without opening the app.
- 8 **Status bar** indicator icons are shown at the top of the display. The right side of the status bar shows the mobile signal strength, Wi-Fi signal strength, and how much battery charge is left. The left side shows the time and app notifications.

Android navigation keys

The TSC5 controller includes navigation keys on the physical keyboard, so they do not appear on the screen.

Status bar

The Status bar shows different status icons for various functions and apps on the device. Common icons show the battery charge status, Wi-Fi signal and connection status, mobile broadband signal and connection status, and Bluetooth connection status.

Apps screen

To see all apps that are pre-installed on the device and those that you downloaded from Google Play, swipe up on the **Home** screen to access the **Apps** screen:

On the **Apps** screen:

- To open an app, tap its icon.
- To search apps, enter the name of the app you are looking for in the **Search apps** bar.
- To place an app icon on a **Home** screen, see [Adding apps to a Home screen, page 62](#).
- To get more apps, tap the Google Play icon .
- Explore apps. Swipe up and down from the **Apps** screen to view the full list of apps installed on your device.

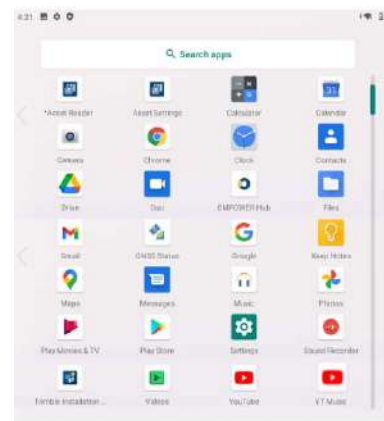

Adding apps to a Home screen

1. From the **Home** screen (or any **Home** screen if you have more than one) open the **Apps** screen.
2. Swipe up or down to find the app you want.
3. Touch-hold the app, then slide the app icon to any **Home** screen and place it where you want it, and then lift your finger off the screen.

Removing an app, shortcut, widget or group from the Home screen

1. Touch-hold the item.
2. Drag the item up to **Remove**.
3. Lift your finger. You can then **Remove**, **Uninstall**, or both. **Remove** removes the shortcut off your **Home** screen. **Uninstall** uninstalls it from the device.

To move an app icon from the primary **Home** screen to another **Home** screen, touch-hold it, then slide the app icon to another **Home** screen.

Uninstalling apps

1. Touch-hold the item.
2. Drag the item up to **Uninstall**.
3. Lift your finger off the screen. You can then **Remove**, **Uninstall**, or both. **Remove** removes the shortcut off your **Home** screen. **Uninstall** uninstalls it from the device.

Alternatively:

1. Touch-hold the app until **App info** appears, then lift your finger off the screen.
2. Tap **App info**.
3. On the App info screen, select **UNINSTALL** to remove the app.

Using the pre-installed Google apps and other apps

The TSC5 controller comes with a range of useful pre-installed software. The following describes some important bundled applications and summarizes what they can be used for.

Google bundled apps



Google Play is a global online store to find, enjoy, and share your favorite apps, games, movies, music, and books on all your favorite devices.



Google app keeps you in the know about things that matter to you. Find quick answers, explore your interests, and stay up to date with Discover. The more you use the Google app, the better it gets.



Google Chrome is a fast, easy to use, and secure web browser. Designed for Android, Chrome brings you personalized news articles, quick links to your favorite sites, downloads, and Google Search and Google Translate built-in. Enjoy the same Chrome web browser experience you love across all your devices.



Gmail is an easy to use email app that saves you time and keeps your messages safe. Get your messages instantly via push notifications, read and respond online and offline, and find any message quickly.



Google Maps allows you to navigate your world faster and easier with over 220 countries and territories mapped and hundreds of millions of businesses and places on the map. Get real-time GPS navigation, traffic, and transit info, and explore local neighborhoods by knowing where to eat, drink and go—no matter what part of the world you're in.



YouTube is the official app for Android devices which allows you to see what the world is watching—from the hottest music videos to what's trending in gaming, entertainment, news, and more. Subscribe to channels you love, share with friends, and watch on any device.



Google Drive is a safe place to back up and access all your files from any device. Easily invite others to view, edit, or leave comments on any of your files or folders. With Drive, you can safely store and access your files anywhere, quickly access recent and important files, search for files by name and content, share and set permissions for files and folders, view your content on the go while offline, receive notifications about important activity on your files, and use the device camera to scan paper documents.



YouTube Music is a music app that allows you to easily find what you're looking for and discover new music. Get playlists and recommendations served to you based on your context, tastes, and what's trending around you.



Google TV, previously Play Movies & TV, makes it easy to find and enjoy the entertainment you love in one place. With Google TV, you'll be able to browse movies and TV episodes across all of your streaming apps, see the latest releases, and create a watchlist shared across devices.



Google Duo is a simple, high-quality video chat application for everyone. With its easy one-tap interface, Google Duo gives users simple, high quality video communication that just works on any device, so they never miss a moment with the people who matter most.



Google Photos is the home for all your photos and videos, automatically organized and easy to find so you can share and save what matters.



Calculator provides simple and advanced mathematical functions.



Google Calendar is the official Google Calendar app to manage your schedule across multiple devices.



Clock combines all of the functionality you need.



Contacts is the official Google app that allows you to back up your contacts and sync them across all your devices. See each contact's email address, phone number, website, and other information at a glance.



Google Keep can be used to take notes, including text, lists, images, and audio.



Messages is Google's official app for texting and can be used to send SMS text messages on to your contacts.



Recorder brings the power of search to audio recording. Meetings, lectures, band practices, family memories—anything you want to save and listen to later. Recorder automatically transcribes and labels what you record so you can easily find the parts that matter to you.

Other bundled apps



Files is a file manager that you can use to view and open recent files, including images, videos, audio and downloads stored on the device or in Google Drive.



Camera. The Camera app lets you take regular photos or video using the rear facing camera on the device.



Trimble EMPOWER Hub is a utility for management of EMPOWER modules on the Trimble EMPOWER enabled devices.



Trimble Installation Manager for Android enables you to easily install and update supported Trimble software to supported devices running the Android platform.



Trimble GNSS Status Utility is a software utility that allows for configuration of the Trimble EM100 GNSS receiver module, and the Trimble R1, R2, and PG200 GNSS receivers. For receivers that support these functions, use the GNSS Status utility to:

- view GNSS status and accuracy information for the currently selected GNSS source
- set up correction sources
- apply licensing options
- configure NMEA output



Asset Reader is a Trimble demo app for the EM110 / EM111 / EM112 barcode and RFID EMPOWER modules. For more information, refer to the documentation at <https://www.trimble.com/empowermodules/>.



Asset Settings is a Trimble settings app which allows configuration of the EM110 / EM111 / EM112 barcode and RFID EMPOWER modules. For more information, refer to the documentation at <https://www.trimble.com/empowermodules/>



Music is a utility for managing songs, albums, artists and playlists stored on the device.



Videos is a utility for videos stored on the device.



Settings

Getting more apps

You can get apps, games, digital content and popular office apps such as Google Docs, Sheets, and Slides for your device using Google Play. Google Play is pre-installed on your TSC5 controller.

1. Open **Apps** and tap Google Play .
2. Use Google Play to search and browse for content to download.

Using wireless networks

- ▶ [Working with Wi-Fi networks](#)
- ▶ [Working with mobile broadband](#)
- ▶ [Airplane mode](#)

The TSC5 controller supports wireless connectivity; connect to wireless networks using the built-in Wi-Fi radio (also sometimes called Wireless LAN, WLAN, or 802.11), or the built-in mobile broadband data (also called Wireless WAN, WWAN, or cellular data) capability.

This section describes how to get online with your TSC5 controller using these wireless networking capabilities.

Working with Wi-Fi networks

Using Wi-Fi you can connect to a wireless network and browse the Internet, download apps, send email messages, access online services, or access other computers and devices on your network.

Before you can send and receive data over Wi-Fi, you need to turn on Wi-Fi on your TSC5 controller and connect to a wireless network.

Working with Wi-Fi networks

Connect to a Wi-Fi wireless network and browse the Internet, download apps, send email messages, access online services, or access other computers and devices on your network.

Before you can send and receive data over Wi-Fi, you need to turn on Wi-Fi on your TSC5 controller and connect to a wireless network.

To access Wi-Fi settings, do one of the following:

- From the **Apps** screen, open the **Settings**  app. Tap **Network & Internet**, then tap **Wi-Fi**.
- On a **Home** screen, swipe down from the status bar at the top of the screen twice with one finger to open **Quick Settings**. If the device is connected to Wi-Fi, the network name is displayed; otherwise, it shows **Wi-Fi**. Tap-hold to open the Wi-Fi settings.

See [The Android interface, page 60](#) for more information on the **Apps** and **Home** screens, and **Quick Settings**.

Connecting to Wi-Fi

1. At the top of the Wi-Fi screen, tap the **On/Off** switch to turn on Wi-Fi. A list of available wireless networks appears.
2. Tap the Wi-Fi network you want to connect to.

If the network is secured and you need a password, you'll see the Wi-Fi lock icon .

Once you are connected:

- **Connected** shows under the network name.
- The Wi-Fi network is a **Saved network**. When in range, your device automatically connects to it.

Disconnecting from a Wi-Fi network

At the top of the Wi-Fi screen, tap the **On/Off** switch to turn off Wi-Fi.

Forgetting a Wi-Fi network

If you do not want your device to automatically connect to a saved Wi-Fi network, you can forget that network.

To forget a wireless network so it no longer appears in your list of networks:

1. From the **Apps** screen, open the **Settings**  app.
2. Tap **Network & Internet**.
3. Tap **Wi-Fi**.
4. At the top of the Wi-Fi screen, make sure the **On/Off** switch is On.
5. Tap the saved network you want to forget, then tap **Forget**.



Advanced Wi-Fi settings

To change the advanced Wi-Fi settings on your device:

1. On the Wi-Fi screen, tap **Wi-Fi preferences** then tap **Advanced**.
2. Tap an available setting option:
 - **Turn on Wi-Fi automatically.** Wi-Fi will turn on near high-quality saved networks, e.g. your home network.
 - **Open network notification.** Get a notification when your device finds a Wi-Fi network to which it can connect.
 - **Install certificates.** Digital certificates can identify your device for many purposes, including VPN or Wi-Fi network access.
 - **Network rating provider.** Select None or Google.
 - **Wi-Fi Direct.** Let your device connect with other Wi-Fi Direct-capable devices without a network.
 - **MAC address**
 - **IP address**

Configure proxy settings

To connect to a Wi-Fi network via a proxy:

1. From the Apps screen, open the **Settings**  app.
2. Tap **Network & Internet / Wi-Fi**.
3. Tap a network.
4. At the top, tap **Edit**  / **Advanced options**.
5. Under **Proxy**, tap the dropdown arrow and select the configuration type:
 - **None**
 - **Manual**
 - **Proxy Auto-Config**
6. If needed, enter the proxy settings.
7. Tap **Save**.

Proxy settings must be set up separately for each Wi-Fi network.

Managing Wi-Fi from the Status bar / Quick Settings on the Home screen

You can quickly turn Wi-Fi on or off, or switch networks, from the **Status** bar / **Quick Settings** on a **Home** screen.

On a **Home** screen, swipe down from the **Status** bar at the top of the screen twice with one finger to open **Quick Settings**. If the device is connected to Wi-Fi, the network name is displayed; otherwise, it shows **Wi-Fi**.

- To turn Wi-Fi on if it is off, tap the Wi-Fi icon.
- To turn Wi-Fi off if it is on, tap the Wi-Fi network that the device is connected to.
- To connect to a different network, tap the dropdown arrow then select the network you want to connect to.

See [The Android interface, page 60](#) for more information on the **Status** bar and **Quick Settings**.

Working with mobile broadband

The TSC5 controller has an integrated cellular modem enabling you to connect to a mobile broadband network. The TSC5 controller supports Worldwide LTE (where available), and is compatible with AT&T and Verizon certified 3G and 4G networks.

Before you can send and receive data over mobile broadband, you must have a MicroSIM card in the device (see [Inserting a MicroSIM card \(optional\), page 31](#)). You must then turn on Cellular data on the TSC5 controller and configure the connection.

Using mobile data

You can adjust how your device uses mobile data by changing your cellular network settings.

Depending on your carrier and service plan, your device may connect automatically to your carrier's fastest available data network. Or you may need to choose settings and use a SIM card for a specific carrier.

To adjust cellular network settings:

1. From the **Apps** screen, open the **Settings**  app.
2. Tap **Network & Internet**, then tap **Mobile network**.
3. Adjust the settings as required:

- **Mobile data.** Access data using mobile network.
- **Roaming.** Let your device transmit data over other carriers' networks when you leave an area covered by your own carrier's networks.
- **App Data** usage.

Locating the device's IMEI number

The IMEI number is a unique 15-digit number that identifies the cellular module installed on your device. Your mobile broadband operator may need to know the IMEI number of your device to register the device with the network and activate your mobile broadband data plan.

The IMEI number is printed on the serial number label located in the SIM card compartment on the back of the device; see [Inserting a MicroSIM card \(optional\)](#), page 31 for instructions on removing the compartment cover.

Alternatively, to check the IMEI number in the operating system:

1. From the **Apps** screen, open the **Settings**  app.
2. Tap **About device**.
3. Tap **IMEI**.

If you cannot find the IMEI number for your device, or you do not have the device with you, contact your reseller.

Airplane mode

If you are traveling on an airplane, or don't need to use wireless functions on the TSC5 controller for a while, use Airplane mode to turn on or off all wireless radios with transmitting features built into the TSC5 controller, including Bluetooth, Wi-Fi, Cellular, as well as any wireless radios connected to the TSC5 controller such as EMPOWER modules.

To turn Airplane mode on or off:

1. Swipe down from the top edge of the screen twice to open **Quick Settings** (see [The Android interface](#), page 60 for more information about Quick Settings).
2. Tap the Airplane mode icon to turn it on or off.

Working with GNSS

- ▶ [Using the GNSS Status Utility](#)
- ▶ [Using 3rd party applications](#)
- ▶ [Calibrating the compass](#)

The TSC5 controller has a built-in 10 m accuracy GNSS (Global Navigation Satellite System) receiver module, and an integrated antenna with automatic SBAS corrections. The integrated receiver supports SBAS satellites under normal conditions.

The TSC5 controller supports most of the external Trimble GNSS receivers, including the submeter Trimble EMPOWER EM100 GNSS receiver module. Refer to the documentation for the receiver you want to use, and check the specifications and connection options. If you want to connect via Bluetooth make sure your receiver is capable of using a Bluetooth PIN; older receivers may not connect due to the security expectations of the Android operating system.

You cannot use an external antenna with the controller's integrated GNSS receiver. For advanced GNSS setups, use a survey grade receiver, or the EM100 GNSS receiver module; refer to the [Trimble EMPOWER module user documentation](#) for more information. With a GNSS L1/L-band GNSS module you can receive GNSS positions with submeter accuracy.

You cannot postprocess GNSS data from the internal receiver. If you want raw GNSS data for postprocessing, use an external GNSS receiver or the EM100 GNSS receiver module; refer to the [Trimble EMPOWER module user documentation](#) for more information.

Using the GNSS Status Utility

The Trimble GNSS Status utility allows you to configure the EM100 GNSS receiver module, and the R1, R2, and PG200 GNSS receivers. For receivers that support these functions, use the GNSS Status utility to:

- view GNSS status and accuracy information for the currently selected GNSS source
- set up correction sources
- apply licensing options
- configure NMEA output

If required, you can update or download it from Google Play.

NOTE – The built-in GNSS is hosted on the WWAN module, so you cannot connect to it directly to configure it (using the GNSS Status utility or any other 3rd party apps).

Using 3rd party applications

The orientation sensors are active and applications can access and use the sensors. Use Google Play to browse for 3rd party tools that enable you to view sensor output.

Calibrating the compass

 **CAUTION** – If an EMPOWER module is installed or removed from the device, the compass must be re-calibrated, or you may experience poor accuracy.

A device that is exhibiting poor accuracy may have bad calibration data on the device. In most cases, this will be resolved after performing one to four calibrations to clear out bad data and correctly calibrate the device. If the compass still appears inaccurate, more calibrations may improve this.

If the blue dot's beam is wide or pointing in the wrong direction, calibrate the compass:

1. On the device, open the Google Maps app.
2. Make a figure 8 until your compass is calibrated. You should only have to do this a few times.

The beam should become narrow and point in the right direction.

For more information on improving your device accuracy, including the instructions on how to perform a calibration, refer to the [Google Maps Help page](#).

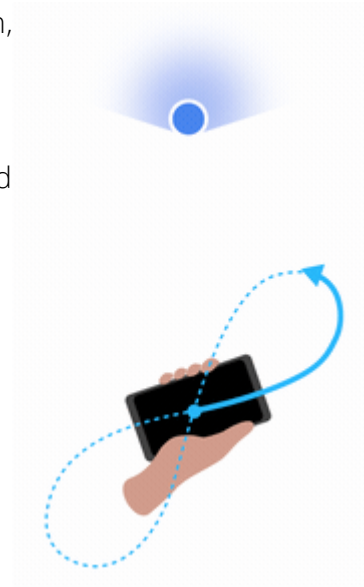

Using accessories and connecting to other devices

- ▶ [Connecting to USB accessories](#)
- ▶ [Connecting to Bluetooth accessories](#)
- ▶ [Connecting to RS-232 peripherals](#)
- ▶ [Transferring data between your TSC5 controller and another computer](#)
- ▶ [Using Trimble EMPOWER modules](#)

Connecting to USB accessories

The TSC5 controller has a USB (type C) port for connecting USB devices, such as a flash drive, scanner, printer, keyboard, or mouse. The TSC5 controller has built-in support for mass storage devices and human interface devices. Other types of USB devices may require drivers from the device manufacturer.

To connect a USB device, plug the device cable into the USB (type C) port on the bottom of the TSC5 controller.



Using USB Type-C locking cables

If a locking USB Type-C cable is required, there are many 3rd party options available. Below are the required specifications for compatible cables with the TSC5 controller.

The Type-C connector should be the dual screw USB Type-C locking plug type, as specified by the [Universal Serial Bus Type-C Locking Connector Specification Revision 1.0 March 9, 2016](#). The below figures are extracted from the above specification, highlighting the required critical dimensions for the locking plug:

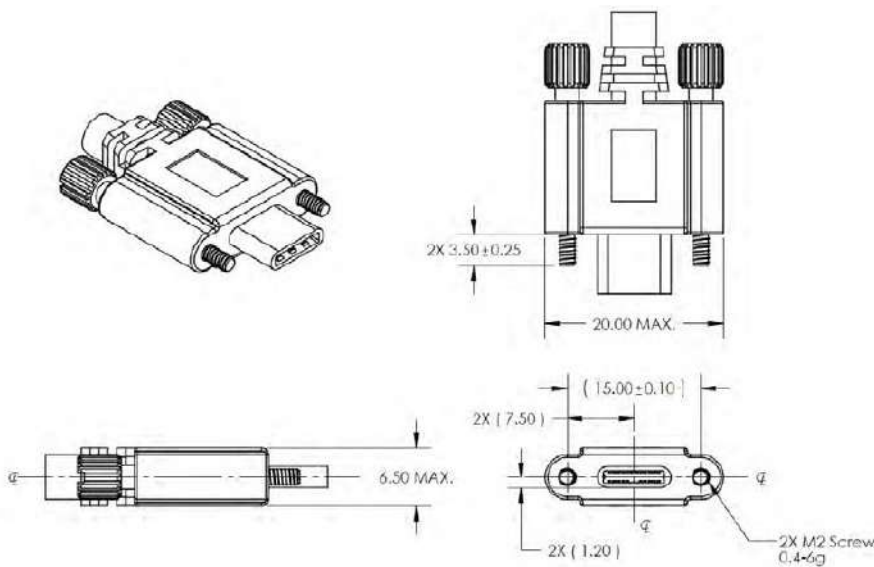

Threaded hole location relative to receptacle for the dual screw version:

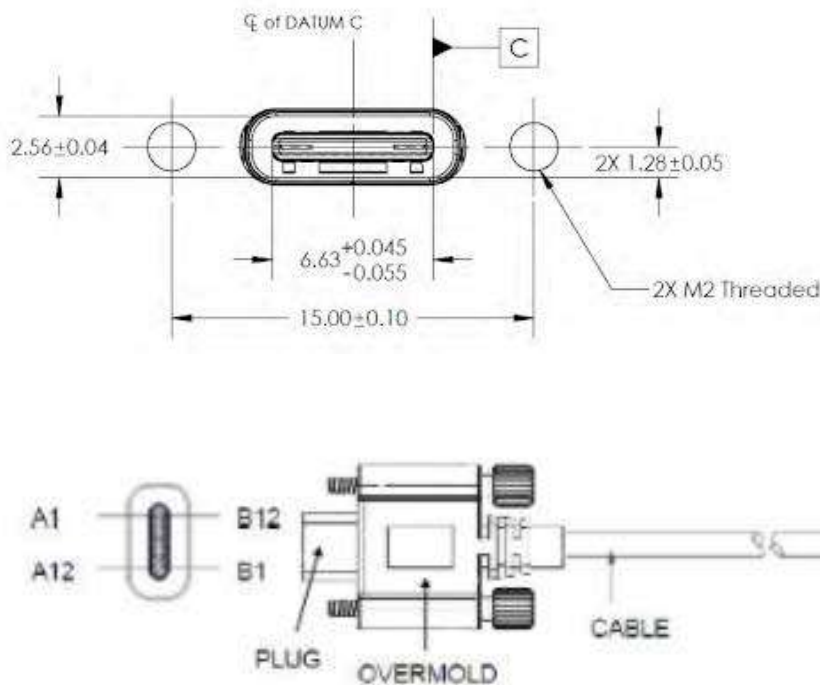

Connecting to Bluetooth accessories

The TSC5 controller has embedded Bluetooth wireless technology—a short-range wireless communication technology that allows wireless data transfer and communication between devices over a distance of up to 100 meters (328 feet).

You can use Bluetooth wireless technology to connect the TSC5 controller to a Bluetooth headset.

Turning Bluetooth on or off

1. Swipe down from the top of the screen.
2. Tap the **Bluetooth** icon  to switch Bluetooth **On** or **Off**.

At the top of the screen, a Bluetooth icon  shows when Bluetooth is turned on and connected to a device.

To save battery, turn off Bluetooth when you are not using it. Bluetooth is off in [Airplane mode](#).

Pairing and connecting a Bluetooth device with the TSC5 controller

Before you can transfer data or communicate between your TSC5 controller and another Bluetooth-enabled device, you must pair the TSC5 controller and the device.

Step 1: Pair a Bluetooth accessory

1. Swipe down from the top of the screen.
2. Tap-hold Bluetooth .
3. Tap **Pair new device**.
4. Tap the name of the Bluetooth device you want to pair with your device.
5. Follow any on-screen instructions. If the pairing is successful, the TSC5 controller connects to the device.

TIP – If you are asked to enter a passcode or Bluetooth PIN, try entering 0000 or 1234 (the most common passcodes), or see the documentation that came with your Bluetooth device. Some old Bluetooth devices do not require a PIN.

NOTE – To connect to a Bluetooth-enabled receiver with a PIN, if for any reason you cannot connect via Bluetooth, connect over Wi-Fi to configure the receiver. The IP address is in most cases 192.168.142.1. Refer to the documentation for the receiver for details and receiver specific settings.

Step 2: Connect to a Bluetooth device

After pairing with a Bluetooth device, you can connect to it manually— for example, to switch devices or to reconnect after a device comes back in range.

1. Swipe down from the top of the screen.
2. Make sure Bluetooth is turned on.
3. Tap-hold Bluetooth .
4. In the list of paired devices, tap a paired but unconnected device.

When your phone and the Bluetooth device are connected, the device shows as **Connected**.

Connecting to RS-232 peripherals

If you require an RS-232 port, you can connect a 3rd party USB-C to RS-232 adapter.

To connect an RS-232 device, plug the device cable into the RS-232 adapter port and plug the USB-C plug on the adapter into the USB-C port on the TSC5 controller.

The adapter may require drivers to be installed on the TSC5 controller. Refer to the documentation for the RS-232 device for instructions on setting up and using the device.

Transferring data between your TSC5 controller and another computer

You can transfer data or files between your TSC5 controller and another device. There are a number of ways you can do this, including:

- using a USB (type C) data transfer cable. See [Transferring data using a USB-C cable, page 79](#).
- using a USB (type C) memory stick; see [Connecting to USB accessories, page 75](#).
- via Wireless LAN; see [Working with Wi-Fi networks, page 67](#).
- using cloud-based file sync services, such as [Dropbox](#), [Microsoft OneDrive](#), [Google Drive](#) over Wi-Fi or 4G.

Transferring data using a USB-C cable

You can transfer data to a device powered by a Windows[®] operating system or to a MacOS device using a USB (type C) data cable.

Transfer with the Windows operating system

1. Unlock the screen on the TSC5 controller.
2. Use a USB type C data transfer cable to connect the TSC5 controller to the Windows device.
3. On the Windows device, follow the prompts to set up the method you want to view and transfer files.
4. On the TSC5 controller, the USB preferences screen should open. Under the **USE USB FOR** section, select **File Transfer**.
5. You can now view and transfer the files on the TSC5 controller from the Windows file browser. Use it to drag and drop files, just like other external storage devices.
6. When you are done, eject the TSC5 controller from the Windows device and unplug the USB cable.

Transfer with a MacOS device

To transfer files, you must have [Android File Transfer](#) installed on your device. Android File Transfer is compatible with MacOS X 10.5 or later and Android 3.0 or later.

1. Download and install Android File Transfer on your MacOS device.
2. Open **Android File Transfer**. (The next time that you connect your device, it should open automatically.)
3. Unlock the screen on the TSC5 controller.
4. Use a USB type C data transfer cable to connect the TSC5 controller to the MacOS device.
5. Swipe down from the top of the TSC5 controller screen to see your notifications.
6. Tap the **USB for...** notification. Then tap **File Transfer**.
7. An **Android File Transfer** window opens. Use it to drag and drop files.
8. When you are done, unplug the USB cable.

Using Trimble EMPOWER modules

The TSC5 controller is part of the Trimble EMPOWER platform, a family of professional modular field devices that can be customized for nearly any application and industry. Each product in this product family is equipped with one or more EMPOWER module bays, which can be used to extend or expand the basic capabilities of your device. Each EMPOWER module can be installed, removed, or moved from one EMPOWER enabled device to another. The EMPOWER platform devices and modules make it easy for you to manage a fleet of devices across multiple users, field roles and job requirements.

For more information about the EMPOWER platform, and the selection of EMPOWER enabled modules that are compatible with your device, contact your local reseller, or go to empower.trimble.com.

The functionality of EMPOWER modules is unlocked through applications and utilities developed specifically for each module. For more information about using Trimble EMPOWER modules, refer to the module documentation at www.trimble.com/empowermodules.

Module functionality can also be directly integrated into field software by developers with access to the Trimble EMPOWER Developer Program using system and module SDKs and APIs. Module Developer Kits are also available to quickly prototype custom modules. For more information on the developer resources and tools available for the TSC5 controller, contact your local reseller, or go to empower.trimble.com/developer.

The TSC5 controller allows one EMPOWER module to be installed at a time.

This section tells you how to install and start using Trimble EMPOWER modules.

- [Attaching and removing EMPOWER modules, page 81](#)
- [Installing EMPOWER module drivers and software apps, page 81](#)

- [Configuring and controlling a module with the Trimble EMPOWER Hub application, page 82](#)

Attaching and removing EMPOWER modules

To attach a module, see [Attaching an EMPOWER module \(optional\), page 37](#).

When you attach a module, make sure that the EMPOWER Hub and other supporting software is updated. See [Installing EMPOWER module drivers and software apps, page 81](#).

You do not need to remove a module from the device unless you need to swap it between devices, or for troubleshooting purposes (e.g., if the device does not recognize the module is attached).

To remove the module:

1. Make sure the [device is turned off](#).
2. Using the Phillips #1 screwdriver, loosen the 2 captive screws at the bottom of the EMPOWER module. Slide the module up and off. Store the module in a safe, dry location to prevent damage to the module interface pogo-pins.

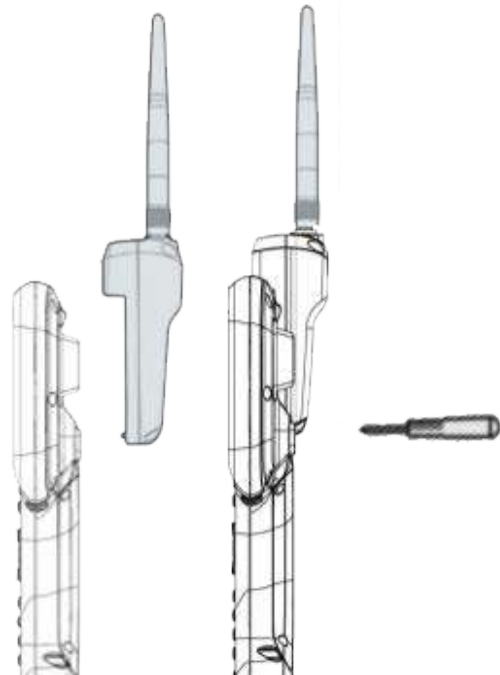

Installing EMPOWER module drivers and software apps

The EMPOWER software and drivers come pre-installed in the operating system. However, before using an EMPOWER module for the first time, you may need to check for updated drivers and software apps on the TSC5 controller for the device to recognize and operate the module. If you need to download or update these components, you can find the apps and drivers on Google Play, which is pre-installed on the TSC5 controller:

1. Open **Apps** and tap **Google Play** .
2. Use Google Play to browse for the drivers and software apps to download.
3. Download the drivers and apps directly to the TSC5 controller.
4. Follow the instructions on the screen to install the drivers and other software as required for your EMPOWER module.

Refer to the documentation supplied with your module for instructions on which components to update and how to use the module and software utilities.

For more information about EMPOWER modules, go to www.trimble.com/empowermodules.

Configuring and controlling a module with the Trimble EMPOWER Hub application

The EMPOWER Hub is a centralized location to control and manage Trimble EMPOWER modules from one convenient, easy-to-use application. The EMPOWER Hub comes pre-installed on the TSC5 controller and can be used to monitor module status and manage modules attached to your device, including:

- View module status information
- Enable and Disable connected modules
- Launch utilities to configure your module(s)
- Configure and launch applications associated with your modules
- Check for and install module firmware updates

Turn on the device and from the **Home** screen, swipe up to open the **Apps** screen. Tap on the EMPOWER Hub icon to start the EMPOWER Hub app.

For more information, refer to the module documentation: www.trimble.com/empowermodules.

TIP – To save battery power, turn off the EMPOWER module if you will not be using it for a prolonged period.

Disabling and enabling modules in the EMPOWER Hub

Refer to the module documentation: www.trimble.com/empowermodules.

Using the cameras

- ▶ Taking photos and videos
- ▶ Changing camera settings
- ▶ Viewing photos and videos

The TSC5 controller is fitted with one rear facing 13MP autofocus camera with LED flash.

The camera is accessible from the Camera app .



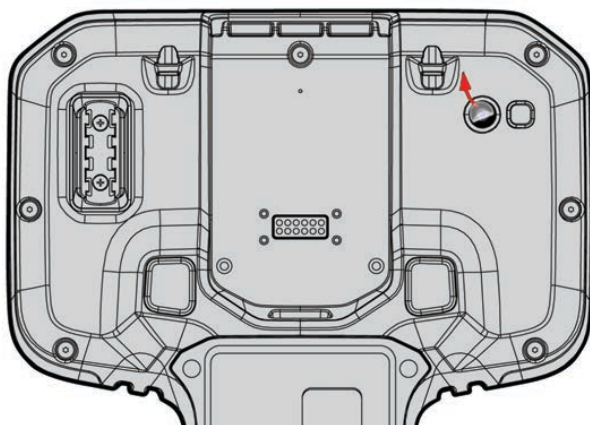



NOTE – The device may be shipped with a protective film covering the camera and flash windows. Remove the film with a fingernail or the plastic stylus tip before first use to ensure proper focus and exposure of your photos and videos.



Taking photos and videos



By default, the built-in Camera app is ready to take photos, but you can switch easily between photo and video mode.

To take a photo or record a video:

1. Swipe up on the **Home** screen to access the Apps screen.
2. Tap  to launch the Camera app.
3. Tap the icon in the top right corner to select the mode you want to use:
 -  Photo
 -  Panorama
 -  Video
4. To take a photo, panorama, or video:
 - a. Point the camera and wait for it to auto-focus.
 - b. To zoom in, move your thumb and forefinger apart on your screen. To zoom out, pinch your thumb and forefinger on your screen.
 - c. To focus on and expose the subject of the photo, tap it on your screen.
 - d. Tap the capture icon in the right center of the screen. The capture icon will vary depending on the mode you selected:
 -  Take a Photo.
 -  Start capturing a Panorama.
 -  Start shooting a Video.
5. To see the photos you've saved, tap the thumbnail image in the corner of the screen.

Changing camera settings

To change how photos or videos are captured:

1. Tap the icon in the top right corner to select the mode you want to change settings for:
 -  Photo
 -  Video
2. Do one of the following:
 - Tap Settings  in the top left corner to access a list of settings specific to photo or video capture.

- Turn the camera flash on, off or auto.
- Turn GPS location On/Off for geo-tagging.
- Choose picture size up to 12 MP.
- Set picture quality / resolution.
- Set countdown timer.
- Choose storage.
- Set manual exposure control.
- Set white balance.
- Turn shutter sound on or off.
- Tap any of the options at the left of the screen to access other settings specific to the active capture mode.

Enable the Camera app to access your location to geo-tag photos

1. In the Camera app, tap Settings .
2. In the **Settings** list, tap **GPS location** to toggle on/off as required.
3. To close the **Settings** list, tap anywhere on the screen off the list.

Viewing photos and videos

By default, your photos and videos are saved to the Photos and Gallery apps on the TSC5 controller; open these apps from the Apps screen.

There are several ways to look through your photos and videos:

- **Camera app:** From within the Camera app, tap an image thumbnail in the bottom right corner of the screen to open the photo. Swipe right or left to scroll through other photos / videos in your collection.
- **Photos app:** Images captured with the Camera app are automatically accessible in the Photos app. Open the Photos app from the Apps screen.
- **Files app:** Images captured with the Camera app are automatically accessible in the Files app. Open the Files app from the Apps screen.

Troubleshooting, downloading updates, and repair

- ▶ [Troubleshooting](#)
- ▶ [Operating system and software updates](#)
- ▶ [Repairing your device](#)

Troubleshooting

This section contains answers to some common troubleshooting questions. If you encounter problems when using your TSC5 controller, try the following troubleshooting tips to detect and solve the problem. If problems persist, contact your local distributor for support.

[Further assistance and support with the Android 10 operating system](#)

For comprehensive online support, how-to guides, troubleshooting articles and related downloads for the Android 10 operating system, go to the online [Android support pages](#) for the Android 10 operating system.

Performance issues

[Device is running slowly, restarts or crashes frequently](#)

If your device is running slowly, keeps rebooting itself, or crashing without restarting, one of the steps below may fix the issue. After following the steps for each recommended solution, check whether it fixed your issue.

Check for Android updates

System updates can bring improvements that may fix your issue. To check for and install system updates:

1. Tap  to open the **Settings** app.
2. Scroll to the bottom and tap **System update**. The update status displays.
3. Follow any on-screen instructions.

Check storage and free up space

You may experience issues if the device's internal storage is full or almost full. The device can start having issues when less than 10% of storage is free.

To check how much storage the device has:

1. Tap  to open the **Settings** app.
2. Tap **Storage** to see how much storage is available.

To free up space that the device needs to work properly, remove unnecessary files and clear cached data.

Check for app updates

App updates can bring improvements that may fix your issue. To see and get updates for your apps:

1. Open **Google Play**.
2. At the top left, tap .
3. Tap **My apps & games**.
4. Apps with available updates are labeled **Update**. If an update is available, tap the app **Update**. If multiple updates are available, tap **Update all**.

Close apps that you are not using

Normally, you don't need to close apps; Android automatically manages the memory that apps use. But to completely shut down an app, including any background services that it may be using:

1. Tap  to open the **Settings** app.
2. Tap **Apps & notifications** then if required tap to expand the list of all apps.

3. Tap the app that you want to close then tap **Force stop**.
4. Tap **Force stop**.

TIP – To help identify apps that cause problems, make a list of which apps you have manually force-stopped.

Check if an app is causing the issue

The issue may be caused by an app that you downloaded. To see whether a downloaded app is causing the issue, you can reboot your device in safe mode. Safe mode temporarily disables all downloaded apps.

1. To reboot the device in safe mode and temporarily disable all downloaded apps, [follow the steps to turn on safe mode](#).
2. Once in safe mode, wait to see if the problem goes away.
 - **If the issue isn't resolved in safe mode**, a downloaded app is most likely not causing the issue. Restart the device and try other troubleshooting solutions. Restart the device and try other troubleshooting solutions.
 - **If the issue is resolved in safe mode**, a downloaded app is most likely causing the issue. To find out which app it is:
 - a. Restart the device to exit safe mode.
 - b. One by one, uninstall recently downloaded apps. After each removal, restart the device and check if the issue is resolved.
 - c. When you have identified and removed the app that was causing the problem, you can reinstall the other apps that you removed.

EMPOWER module issues

My field software doesn't recognize my EMPOWER module

- Check module contacts and attachment.

It is possible the contacts between the module and the device are dirty, or that the module is not attached correctly. Ensure that the module contacts are clean and that the screws are tightened correctly.
- Your field software is not configured to communicate with the EMPOWER module.

Check that your field software supports the EMPOWER module directly and that the field software is configured to talk to the EMPOWER module directly or through the correct COM port.

The EMPOWER Hub doesn't show my module

- Check module contacts and attachment.

It is possible the contacts between the module and the device are dirty, or that the module is not attached correctly. Ensure that the module contacts are clean and that the screws are tightened correctly.

Refer to the Trimble EMPOWER modules documentation here www.trimble.com/empowermodules for more information.

Wireless connectivity issues

Wi-Fi speed is slow

- Your network is running slow for all devices.

You should first check to see whether your network is slow on another device. Can you connect to your wireless network and browse the web at normal speeds from another device? Try running a Network Speed Test to ensure your Internet connection is functioning normally.

- Your Wi-Fi signal is weak.

Look at the Wireless network icon in the Notifications bar.

This icon  shows your current signal strength. If the icon is partially dimmed, move your device closer to your wireless router to see if the signal improves. If your router is broadcasting on both a 2.4GHz and 5GHz frequency, try connecting to a different frequency. In general, a network operating on the 5GHz frequency will be faster and less susceptible to interference, but will have a shorter range than a 2.4GHz network.

GNSS accuracy issues

You may need to re-calibrate the compass, especially if you have removed or [installed an EMPOWER module](#).

See [Calibrating the compass, page 73](#) for more information.

Power and battery issues

Battery will not charge

- The battery is overheated, or too cold.

The battery will charge between 0 °C and +40 °C (+32 °F and +104 °F). If you have been using or storing the battery and/or device in a particularly hot or cold environment, the

battery may be outside the safe charging temperature range. Sensors in the battery will prevent the battery from charging until its temperature returns to a normal level.

Device will not start up

- The batteries do not have enough charge to power the device:

The internal batteries must be partially charged to boot the device, and the device must be between -20°C and $+60^{\circ}\text{C}$ (-4°F and $+140^{\circ}\text{F}$) to boot up. Plug the charger into the device and leave on charge for 30 minutes then try to boot the device. If you see a battery indicator with a red charge level and charger icon, it needs to continue charging before the device can turn on.

Device suddenly turned off during use

- Make sure you are not accidentally pressing the Power key.

The Power key is located on the left side of the keyboard. Make sure that while gripping the device you are not accidentally pressing the Power key, which places the device into suspend mode.

- The device may have run out of power.

If your device's battery charge level gets too low, the device will automatically power down to prevent loss of data. You must charge the internal batteries before it will turn on. See [Checking the battery charge levels and LED status, page 42](#) for more information on batteries.

Restarting or resetting the operating system

If your device becomes unresponsive, and the troubleshooting guide does not resolve the problem, you need to restart or reset your device.

Restarting your (unresponsive) device

If your device is no longer responding to touchscreen or keyboard input, you may need to force it to restart by removing power from the system.

NOTE – Restarting the system by holding down the Power key removes power to the CPU. Any unsaved files and settings will be lost.

To force your device to restart:

1. Press-hold the Power key until the **Power Off** and **Restart** options appear on the screen.
2. Tap **Restart** to restart the device.

Resetting your device to factory default settings

If restarting your device does not resolve the issue that you are seeing, resetting it might help.

You can remove all data from your device by resetting it to factory settings.

 **WARNING** – A factory reset wipes all data from the device. While any data stored in your Google Account will be restored, all apps and their associated data will be uninstalled.

 **WARNING** – Your device is protected to prevent other people from using it if it's been reset to factory settings. After a factory reset, you'll need to enter your Google username and password associated with the device. If you don't have this information, you won't be able to finish the setup process and use the device at all after the factory reset.

Erasing your data may take some time, so make sure that you plug your device into a power source before you start.

1. Tap  to open the **Settings** app.
2. Tap **System**, then tap **Advanced**.
3. Tap **Reset options**, and then tap the reset option you want to use:
 - **Reset Wi-Fi, Mobile & Bluetooth**
 - **Reset app preferences**
 - **Erase all data (factory reset)**. Select this option to factory reset the device to the original state it was shipped in.
4. Follow the on-screen instructions for the option you selected. You may need to enter your unlock pattern, PIN, or password.
5. When the device has finished erasing, you'll be prompted to go through the new device setup.

Operating system and software updates

Periodically, operating system and software application updates will be available for your device.

Android 10 updates

Any operating system updates for your device will be available to you over the air.

- See [Check for Android updates, page 87](#)
- See [Check for app updates, page 87](#)

Software downloads and updates

The latest versions of software including drivers, firmware updates, and software utilities, are available on Google Play. Additional material and information can be found on the Trimble [technical support pages](#) on www.trimble.com.

Repairing your device

Before you send your TSC5 controller for repair, check the troubleshooting tips in this document. If you can't solve the problem with troubleshooting, contact your local Trimble dealer for further support.

Repair of this product should only be performed by a Trimble Authorized Service Provider. Any attempt to disassemble this product by a non-authorized service provider will void the warranty.

For more information, contact your local Trimble dealer.

